



Aluminios Iberica, Lda



PALA - MIGUEL & REIS, LDA.



EXEMPLO CONCRETO

Painéis Sandwich - Perfis - Chapas - Remates - Acessórios



ALUMÍNIOS DE VISEU, LDA.



ANGULAR - Alumínios, Lda.

Catálogo Celosias e Lâminas Decorativas



CELOSÍAS Y LAMAS DECORATIVAS

Perfiles a escala

SHUTTERS AND LOUVRES

Profiles to scale

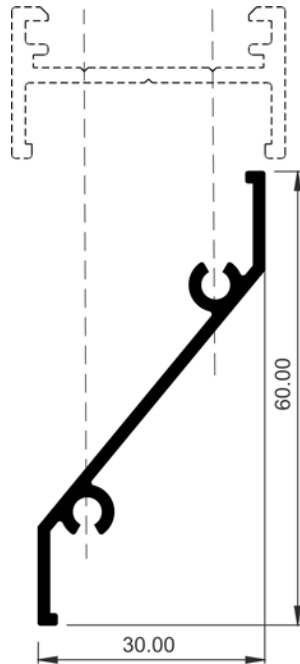

770220	
Descripción Description	Lama Louvre
Peso Weight (g/m)	399,6
Superficie Surface (dm ² /m)	18,57
Ix (cm⁴)	3,86
Iy (cm⁴)	1,51
Observaciones Observations	Válido para marco COR-2748 Valid for frame COR- 2748

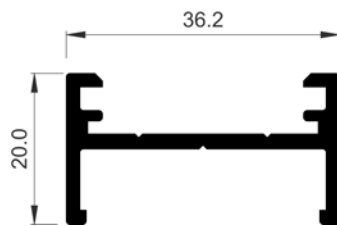

COR-2748	
Descripción Description	Marco para celosias Shutter frame
Peso Weight (g/m)	434,7
Superficie Surface (dm ² /m)	16,87
Ix (cm⁴)	0,35
Iy (cm⁴)	3,27
Observaciones Observations	Válido con lamas COR-2749 y 770220 Valid for louvres Cor- 2749 and 770220

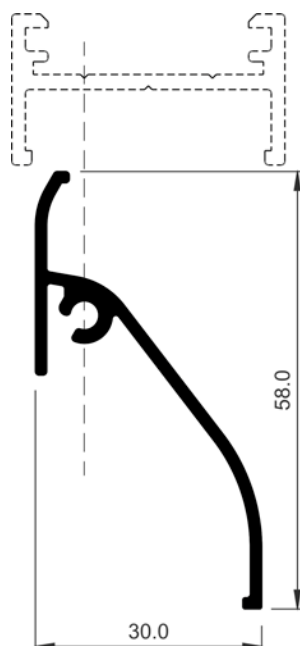

COR-2749	
Descripción Description	Lama fija para celosias Fixed louvre for shutters
Peso Weight (g/m)	413,1
Superficie Surface (dm ² /m)	18,79
Ix (cm⁴)	3,15
Iy (cm⁴)	1,76
Observaciones Observations	Válido para marco COR-2748 Valid for COR-2748 frame

CELOSÍAS Y LAMAS DECORATIVAS

Perfiles a escala

SHUTTERS AND LOUVRES

Profiles to scale

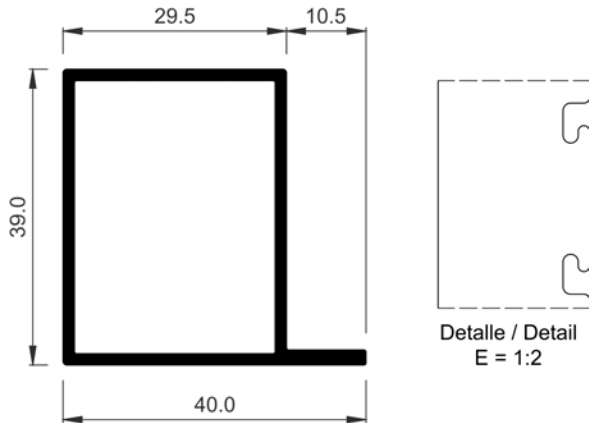

COR-2823	
Descripción Description	Soporte celosías clip mecanizado Support for shutters clip machined
Peso Weight (g/m)	580,5
Superficie Surface (dm ² /m)	28,17
I_x (cm ⁴)	4,92
I_y (cm ⁴)	3,53
Escuadra principal Main cleat	257082

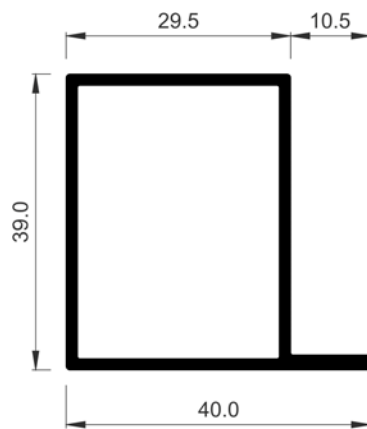

COR-2827	
Descripción Description	Soporte celosías clip Support for shutters clip
Peso Weight (g/m)	580,5
Superficie Surface (dm ² /m)	28,17
I_x (cm ⁴)	4,92
I_y (cm ⁴)	3,53
Escuadra principal Main cleat	257082

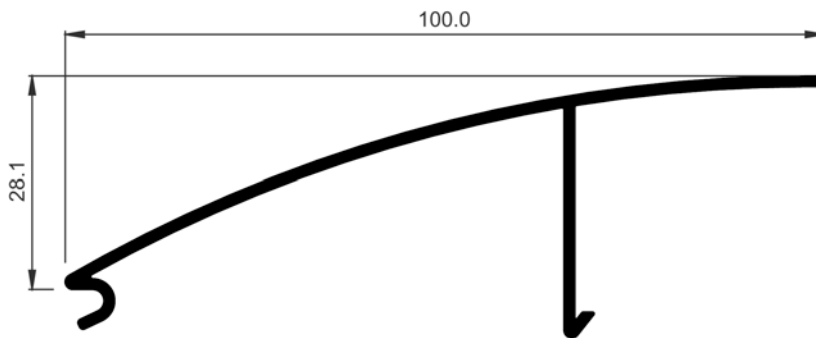

COR-2828	
Descripción Description	Lama curva celosías clip Curve louvre shutters clip
Peso Weight (g/m)	564,3
Superficie Surface (dm ² /m)	29,53
I_x (cm ⁴)	2,2
I_y (cm ⁴)	16,88

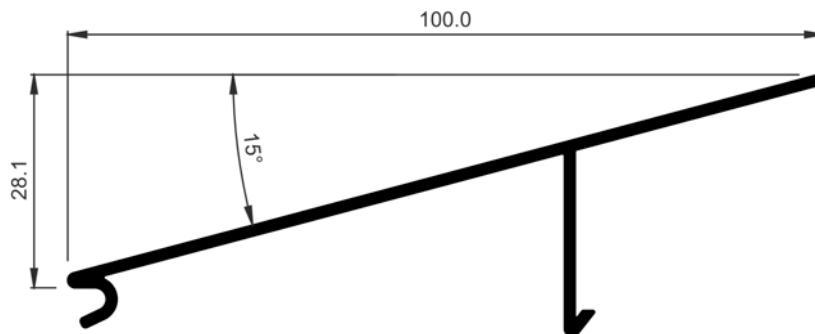

COR-2829	
Descripción Description	Lama recta celosías clip Straight louvre shutters clip
Peso Weight (g/m)	534,6
Superficie Surface (dm ² /m)	27,79
I_x (cm ⁴)	1,61
I_y (cm ⁴)	16,24

CELOSÍAS Y LAMAS DECORATIVAS

Perfiles a escala

SHUTTERS AND LOUVRES

Profiles to scale

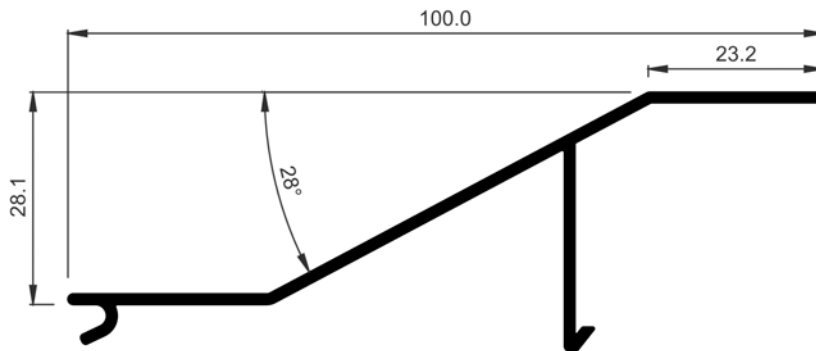

COR-2830	
Descripción Description	Lama Z celosías clip Z louver shutters clip
Peso Weight (g/m)	542,7
Superficie Surface (dm ² /m)	28,62
Ix (cm ⁴)	2,38
Iy (cm ⁴)	14,97

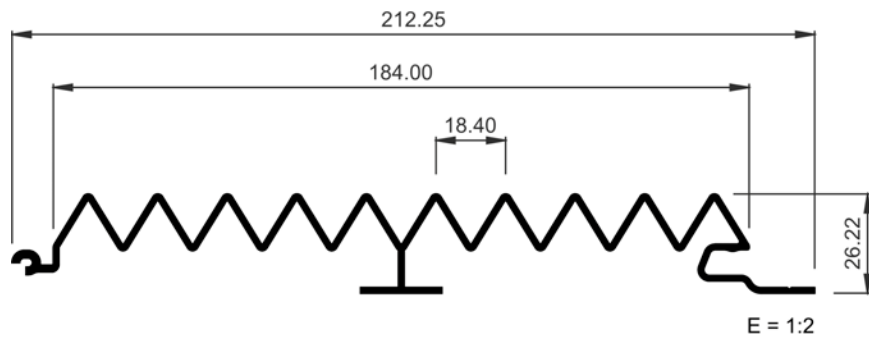

770036	
Descripción Description	Lama perfilada Prifiled louvre
Peso Weight (g/m)	1722,6
Superficie Surface (dm ² /m)	86,01
Ix (cm ⁴)	3,25
Iy (cm ⁴)	228,88

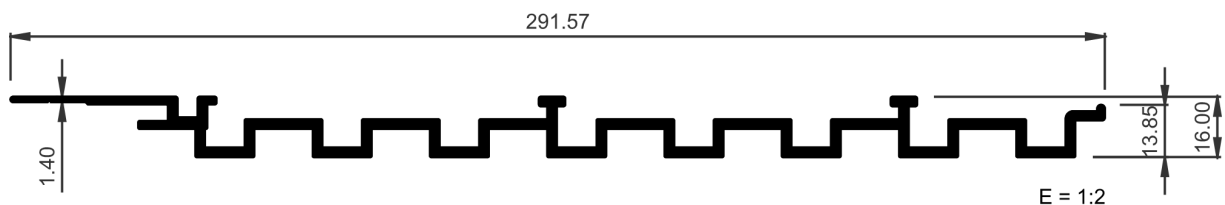

770080	
Descripción Description	Lama onda cuadrada Square ondulated louvre
Peso Weight (g/m)	2995,4
Superficie Surface (dm ² /m)	90,79
Ix (cm ⁴)	2,23
Iy (cm ⁴)	713,13

CELOSÍAS Y LAMAS DECORATIVAS

Perfiles a escala

SHUTTERS AND LOUVRES

Profiles to scale

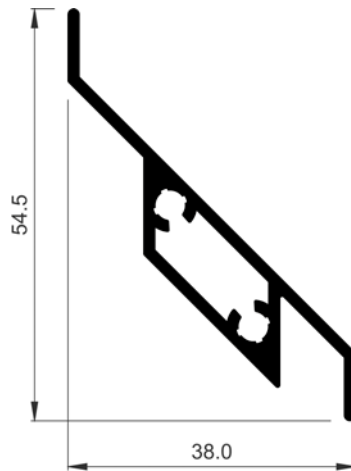

COR-1747	
Descripción Description	Lama fija de 38 mm para celosía 38 mm fixed louvre for shutters
Peso Weight (g/m)	529,2
Superficie Surface (dm ² /m)	23,64
Ix (cm⁴)	3,27
Iy (cm⁴)	2,14
Observaciones Observations	CONSULTAR DISPONIBILIDAD CHECK AVAILABILITY

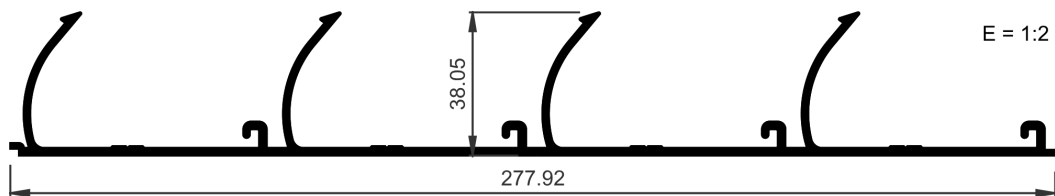

COR-2746	
Descripción Description	Soporte de lama para celosías Louvre support for shutters
Peso Weight (g/m)	2578,5
Superficie Surface (dm ² /m)	98,61
Ix (cm⁴)	11,17
Iy (cm⁴)	620,9
Observaciones Observations	Clipa con perfil Cor-2747 Clip with profile Cor-2747

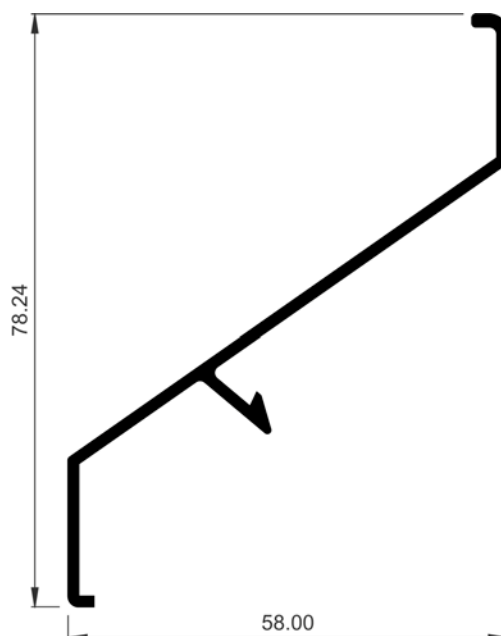

COR-2747	
Descripción Description	Lama para celosías Shutter louvre
Peso Weight (g/m)	480,6
Superficie Surface (dm ² /m)	25,05
Ix (cm⁴)	7,41
Iy (cm⁴)	7,45

CELOSÍAS Y LAMAS DECORATIVAS

Perfiles a escala

SHUTTERS AND LOUVRES

Profiles to scale

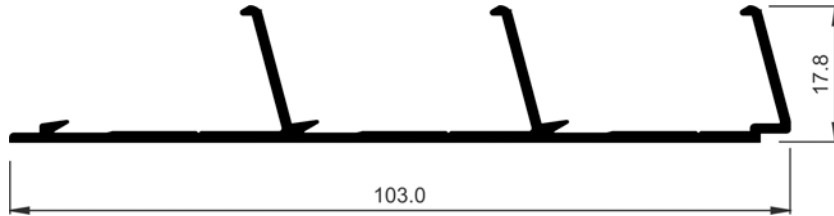

COR-2783	
Descripción Description	Soporte lama ventilación mini Support for mini ventilation louvre
Peso Weight (g/m)	542,7
Superficie Surface (dm ² /m)	32,91
Ix (cm⁴)	0,52
Iy (cm⁴)	17,7

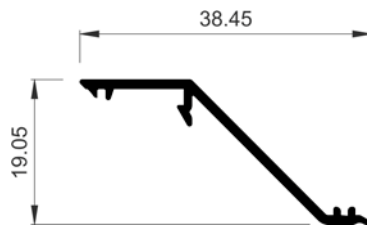

COR-2785	
Descripción Description	Lama de ventilación mini Mini ventilation louvre
Peso Weight (g/m)	167,4
Superficie Surface (dm ² /m)	10,88
Ix (cm⁴)	0,29
Iy (cm⁴)	0,79

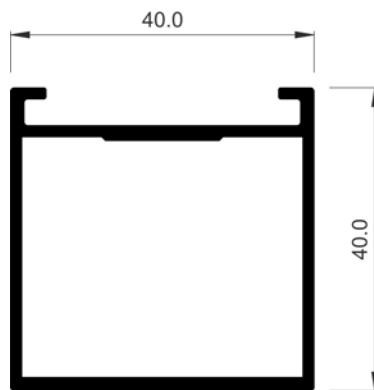

COR-2845	
Descripción Description	Montante portalamas tubular Mullion for tubular louvre guides
Peso Weight (g/m)	704,7
Superficie Surface (dm ² /m)	31,72
Ix (cm⁴)	5,7
Iy (cm⁴)	6,2
Escuadra principal Main cleat	282845

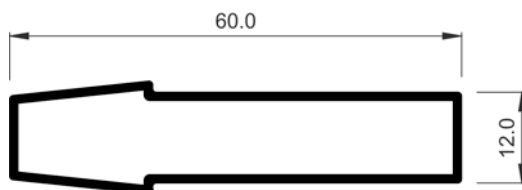

COR-2847	
Descripción Description	Lama tubular Tubular louvre
Peso Weight (g/m)	421,2
Superficie Surface (dm ² /m)	28,14
Ix (cm⁴)	0,45
Iy (cm⁴)	5,79

CELOSÍAS Y LAMAS DECORATIVAS

Perfiles a escala

SHUTTERS AND LOUVRES

Profiles to scale

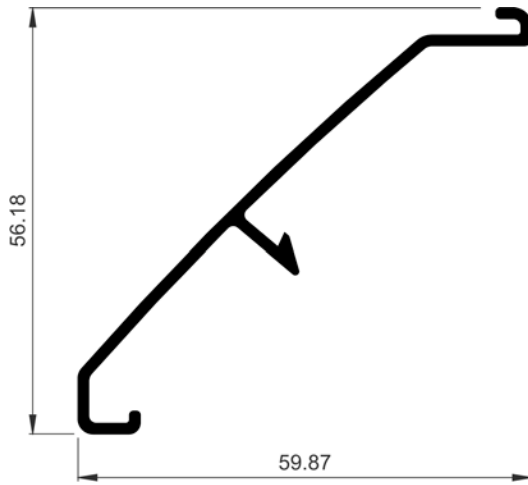

COR-2895	
Descripción Description	Lama para celosías Shutters louvre
Peso Weight (g/m)	423,9
Superficie Surface (dm ² /m)	22,11
Ix (cm ⁴)	4,58
Iy (cm ⁴)	5,05
Observaciones Observations	CONSULTAR DISPONIBILIDAD CHECK AVAILABILITY

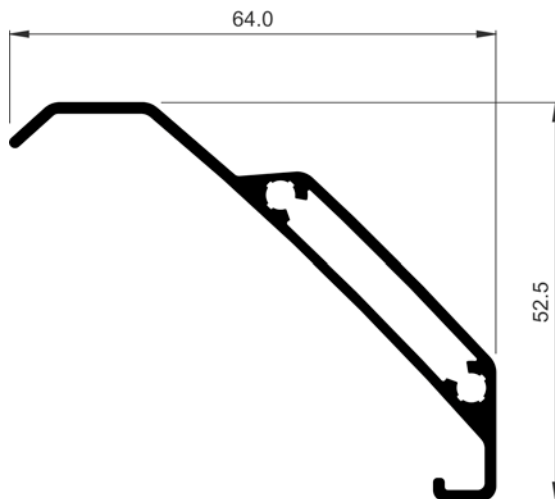

COR-2896	
Descripción Description	Lama fija para celosía Fixed shutters louvre
Peso Weight (g/m)	585,9
Superficie Surface (dm ² /m)	29,91
Ix (cm ⁴)	5,31
Iy (cm ⁴)	7,02
Observaciones Observations	CONSULTAR DISPONIBILIDAD CHECK AVAILABILITY

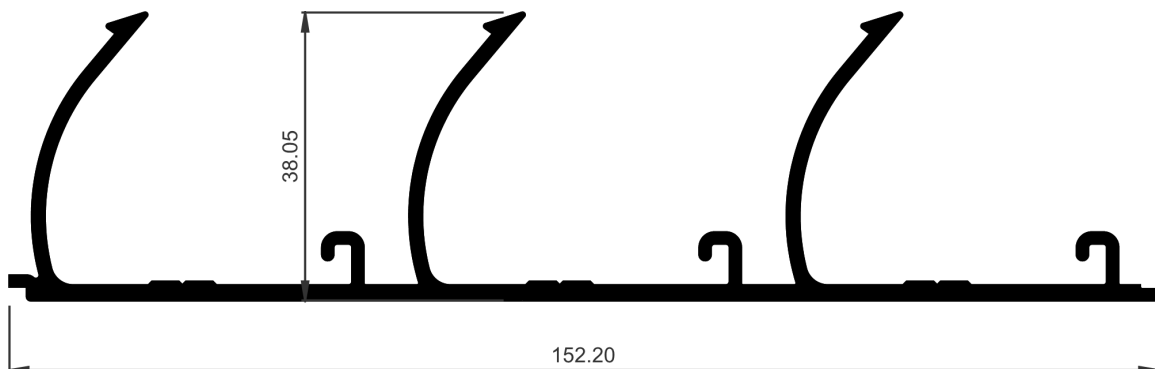

COR-2897	
Descripción Description	Soporte lama para celosías Support for shutters louvre
Peso Weight (g/m)	1579,5
Superficie Surface (dm ² /m)	62,48
Ix (cm ⁴)	7,77
Iy (cm ⁴)	113,1
Observaciones Observations	Clipa con perfil Cor-2895. CONSULTAR DISPONIBILIDAD Clip with profile Cor-2895. CHECK AVAILABILITY

CELOSÍAS Y LAMAS DECORATIVAS

Perfiles a escala

SHUTTERS AND LOUVRES

Profiles to scale



COR-9001	
Descripción Description	Perfil Base Base profile
Peso Weight (g/m)	1420,2
Superficie Surface (dm ² /m)	57,4
Ix (cm ⁴)	0,36
Iy (cm ⁴)	268,87

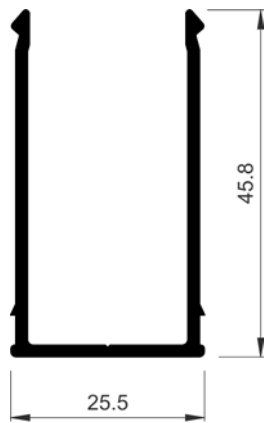

COR-9002	
Descripción Description	U de clipaje U clip
Peso Weight (g/m)	496,8
Superficie Surface (dm ² /m)	23,11
Ix (cm ⁴)	3,93
Iy (cm ⁴)	2,03

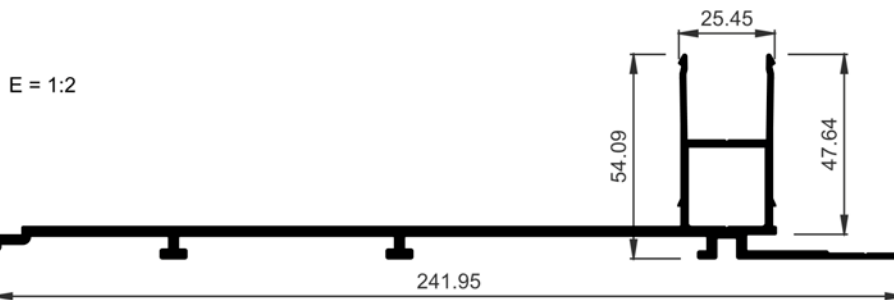

COR-9004	
Descripción Description	Perfil base con U incorporada Base profile with incorporated U
Peso Weight (g/m)	2346,3
Superficie Surface (dm ² /m)	79,56
Ix (cm ⁴)	11,4
Iy (cm ⁴)	400,04
Observaciones Observations	CONSULTAR DISPONIBILIDAD CHECK AVAILABILITY

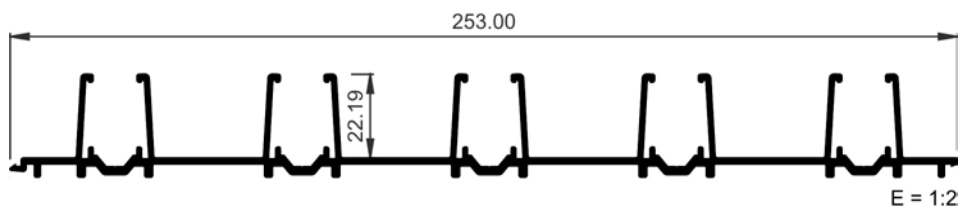

COR-2846	
Descripción Description	Base portalamas tubular Louvre guide base for tubular louvre
Peso Weight (g/m)	2305,8
Superficie Surface (dm ² /m)	113,16
Ix (cm ⁴)	5,09
Iy (cm ⁴)	453,96

CELOSÍAS Y LAMAS DECORATIVAS

Perfiles a escala

SHUTTERS AND LOUVRES

Profiles to scale

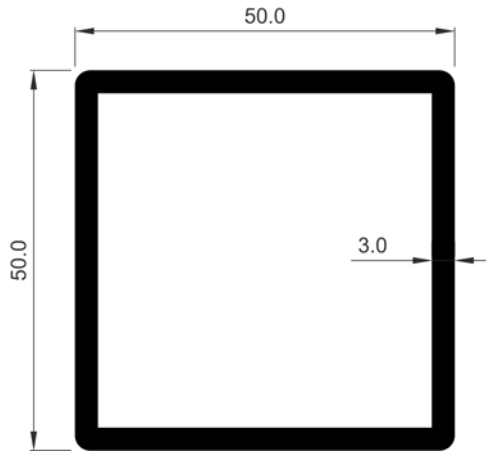

COR-2250	
Descripción Description	Tubo de 50x50x3 mm 50x50x3 mm tube
Peso Weight (g/m)	1514,7
Superficie Surface (dm ² /m)	37,26
I _x (cm ⁴)	20,64
I _y (cm ⁴)	20,64

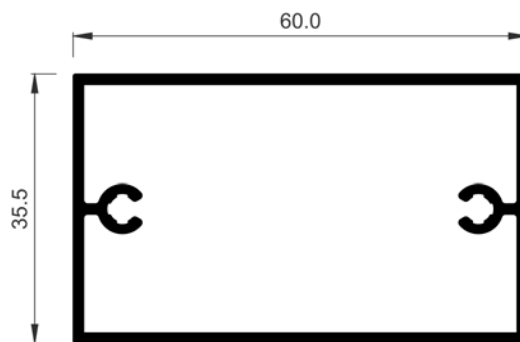

772186	
Descripción Description	Tubo 60x35.5 60x35.5 tube
Peso Weight (g/m)	812,7
Superficie Surface (dm ² /m)	43,16
I _x (cm ⁴)	5,72
I _y (cm ⁴)	15,41
Observaciones Observations	CONSULTAR DISPONIBILIDAD CHECK AVAILABILITY

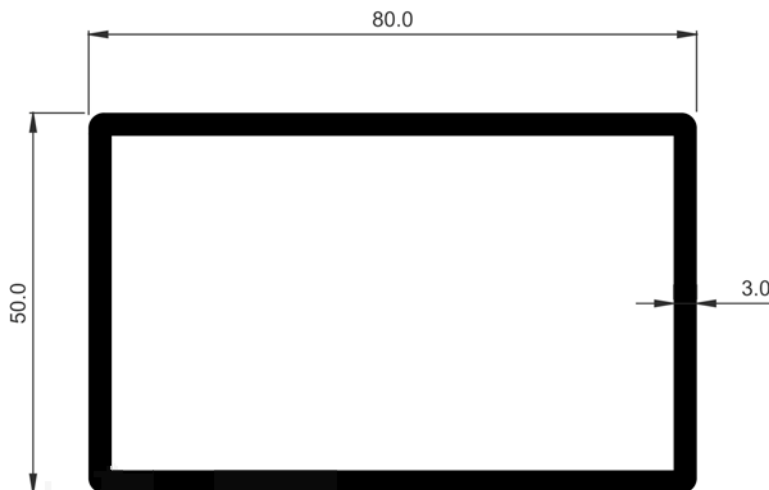

COR-2280	
Descripción Description	Tubo de 80 mm x 50 mm x 3 mm 80 x 50 x 3 mm tube
Peso Weight (g/m)	2000,7
Superficie Surface (dm ² /m)	49,26
I _x (cm ⁴)	64,21
I _y (cm ⁴)	30,6

CELOSÍAS Y LAMAS DECORATIVAS
Perfiles a escala

SHUTTERS AND LOUVRES
Profiles to scale

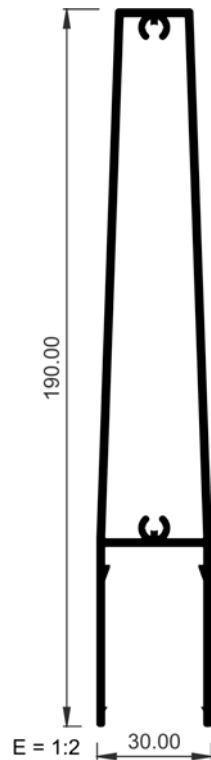

COR-9003	
Descripción Description	Lama vertical 190 mm 190 mm vertical louvre
Peso Weight (g/m)	2311,2
Superficie Surface (dm ² /m)	90,02
Ix (cm⁴)	280,05
Iy (cm⁴)	11,51
Tapas Covers	269002

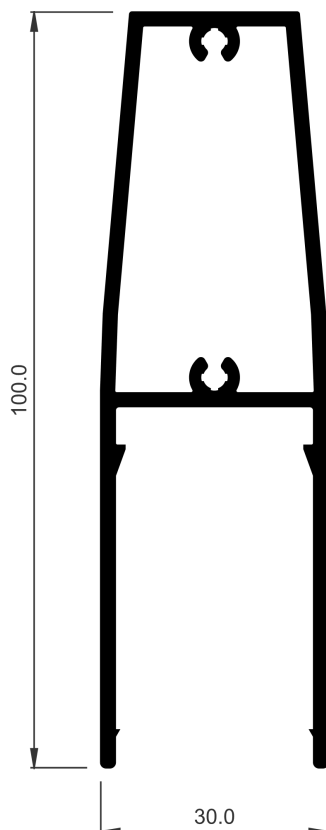

COR-9006	
Descripción Description	Lama vertical de 100 mm 100 mm vertical louvre
Peso Weight (g/m)	1320,3
Superficie Surface (dm ² /m)	52,81
Ix (cm⁴)	41,25
Iy (cm⁴)	7,03
Tapas Covers	369002
Observaciones Observations	CONSULTAR DISPONIBILIDAD CHECK AVAILABILITY

CELOSÍAS Y LAMAS DECORATIVAS
Perfiles a escala

SHUTTERS AND LOUVRES
Profiles to scale

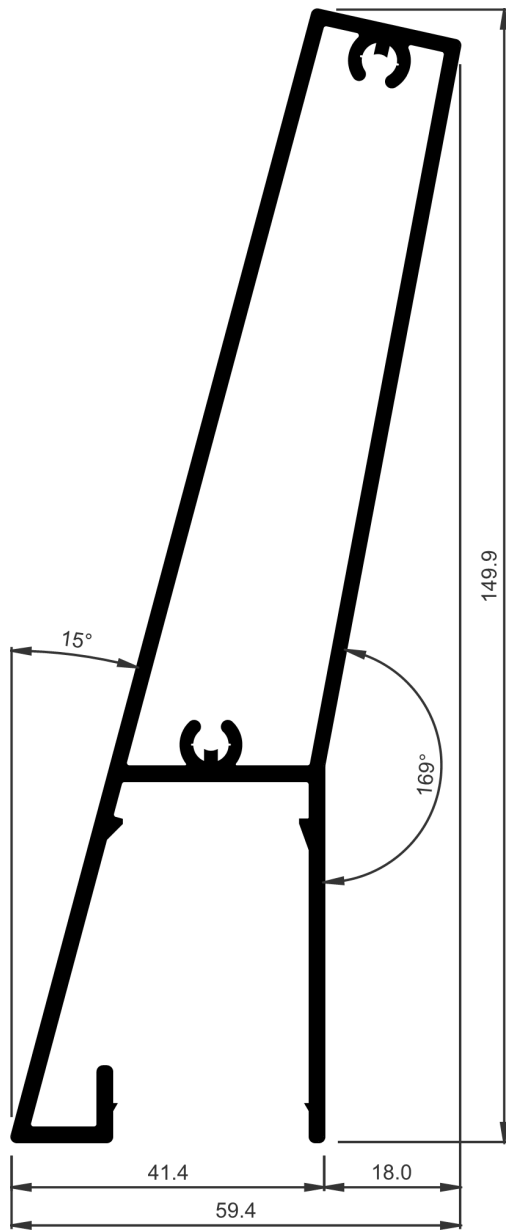

COR-9005	
Descripción Description	Lama vertical 150 mm 150 mm vertical louvre
Peso Weight (g/m)	2000,7
Superficie Surface (dm ² /m)	77,92
Ix (cm⁴)	18,06
Iy (cm⁴)	151,32
Observaciones Observations	CONSULTAR DISPONIBILIDAD CHECK AVAILABILITY



500500	
Descripción Description	Chapa de ondas Wave panel
Peso Weight (g/m)	557,7
Superficie Surface (dm ² /m)	32,5
Ix (cm⁴)	0,18
Iy (cm⁴)	30,58

aluminiosiberica.pai.pt



Aluminios Iberica, Lda

Sede e Fábrica: Rua parque Industrial, Nº 126
4720-536 Lago Amares
Telef. 253 310 250 / 253 310 251 Fax. 253 311 830
Email: geral@aluminiosiberica.pt

Filiais:

Vila Real Lugar de Couços – EN 115
5000-122 Justes – Vila Real
Telef. 259 331 778 / Fax. 259 928 092
Email: vreal@aluminiosiberica.pt



EXEMPLO CONCRETO
Painéis Sandwich - Perfis - Chapas - Remates - Acessórios

Vila Nova de Gaia (Exemplo Concreto, LDA)
Rua Nova de São Caetano, nº3
4405-819 Vilar do Paraíso
Telef. 227 629 539
Email: gaia@exemploconcreto.com



Armazém: Est. Do Campo de Aviação
3510-824 Campo – Viseu
Telef. 232 459 138 / 232 459 741
Fax. 232 450 140
Email: geral@alviz.pt



Armazém: Zona Industrial de Vilamoura
Lote 28 - Apartado 841
8126 -910 Quarteira
Telef. 289 322 748 Fax. 289 301 928
Email: pala.loule@sapo.pt



Armazém: Av. Almirante Gago Coutinho
Portela de Sintra - Apartado 212
2711 - 901 Sintra
Telef. 219 244 074 / 219 244 101 Fax. 219 241 015
Email: angularlda@sapo.pt