



Aluminios Iberica, Lda



PALA - MIGUEL & REIS, LDA.



EXEMPLO CONCRETO

Painéis Sandwich - Perfis - Chapas - Remates - Acessórios



ALUMÍNIOS DE VISEU, LDA.



ANGULAR - Alumínios, Lda.

Catálogo Barandilla Classic



BARANDILLA CLASSIC
Perfiles a escala

CLASSIC BALUSTRADE
Profiles to scale

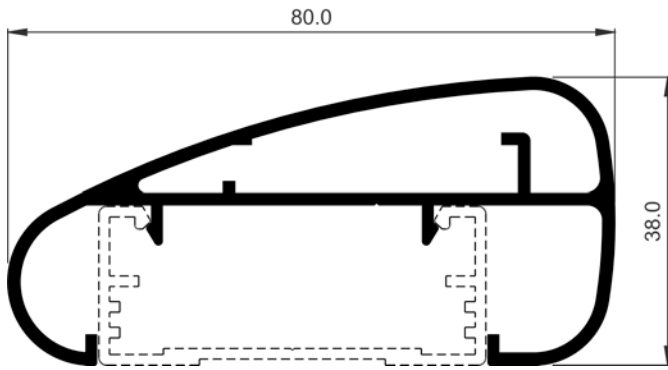

COR-8501	
Descripción Description	Pasamanos Handrail
Peso Weight (g/m)	1031,4
Superficie Surface (dm ² /m)	47,16
I_x (cm ⁴)	4,01
I_y (cm ⁴)	25,82
Escuadra principal Main cleat	908510
Observaciones Observations	Sobre anclaje pasamanos COR-8502 On COR-8502 handrail anchoring

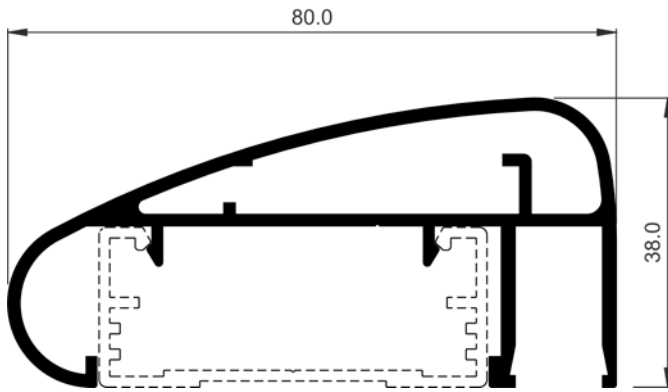

COR-8509	
Descripción Description	Pasamanos Handrail
Peso Weight (g/m)	1090,8
Superficie Surface (dm ² /m)	49,19
I_x (cm ⁴)	4,01
I_y (cm ⁴)	26,96
Escuadra principal Main cleat	908510
Observaciones Observations	Sobre anclaje pasamanos COR-8502 On COR-8502 handrail anchoring

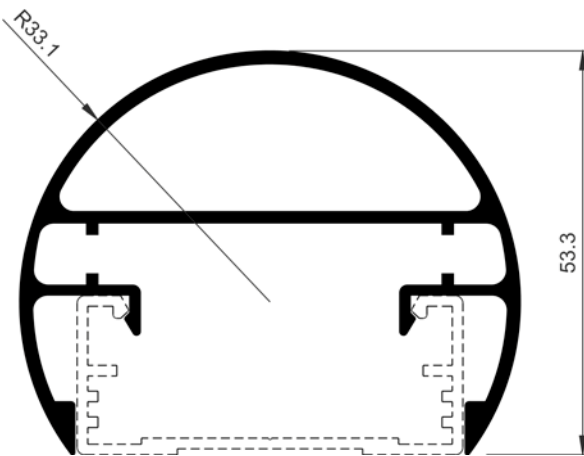

COR-8510	
Descripción Description	Pasamanos Handrail
Peso Weight (g/m)	1109,7
Superficie Surface (dm ² /m)	48,94
I_x (cm ⁴)	7,98
I_y (cm ⁴)	22,44
Escuadra principal Main cleat	908506 908508 908511 908512
Observaciones Observations	Sobre anclaje pasamanos COR-8502 On COR-8502 handrail anchoring

BARANDILLA CLASSIC

Perfiles a escala

CLASSIC BALUSTRADE

Profiles to scale

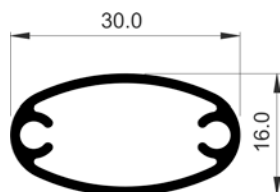
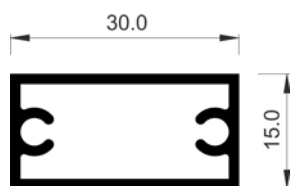
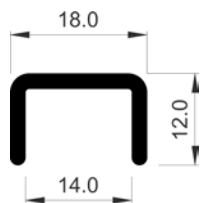
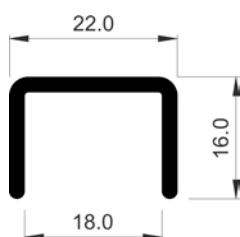
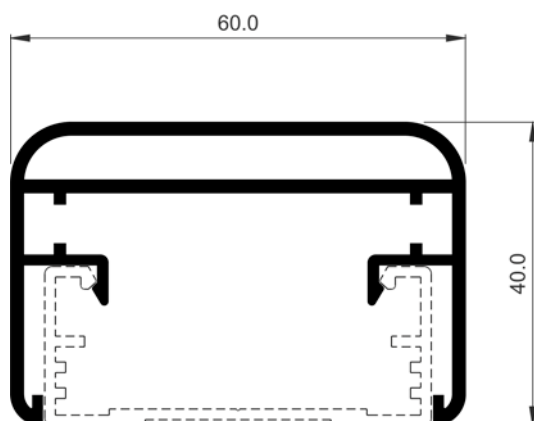

COR-8520	
Descripción Description	Pasamanos Handrail
Peso Weight (g/m)	1026
Superficie Surface (dm ² /m)	46,22
Ix (cm⁴)	4,69
Iy (cm⁴)	18,84
Escuadra principal Main cleat	908506 908508 908511 908512
Observaciones Observations	Sobre anclaje pasamanos COR-8502 On COR-8502 handrail anchoring

COR-8562	
Descripción Description	Remate vidrio 8.8 Glass finishing 8.8
Peso Weight (g/m)	261,9
Superficie Surface (dm ² /m)	9,97
Ix (cm⁴)	2,4
Iy (cm⁴)	7

COR-8563	
Descripción Description	Remate vidrio 6.6 Glass finishing 6.6
Peso Weight (g/m)	197,1
Superficie Surface (dm ² /m)	7,57
Ix (cm⁴)	0,9
Iy (cm⁴)	0,33

500015	
Descripción Description	Barrotillo Baluster
Peso Weight (g/m)	367,2
Superficie Surface (dm ² /m)	20,15
Ix (cm⁴)	0,42
Iy (cm⁴)	1,6
Tornillería Screws	814232

500830	
Descripción Description	Barrotillo Baluster
Peso Weight (g/m)	286,2
Superficie Surface (dm ² /m)	16,42
Ix (cm⁴)	0,28
Iy (cm⁴)	1,05
Tornillería Screws	814232

BARANDILLA CLASSIC
Perfiles a escala

CLASSIC BALUSTRADE
Profiles to scale

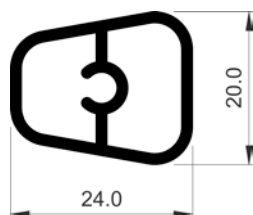

COR-8508	
Descripción Description	Barrotillo Baluster
Peso Weight (g/m)	378
Superficie Surface (dm ² /m)	18,12
Ix (cm⁴)	0,52
Iy (cm⁴)	0,74
Tornillería Screws	814232

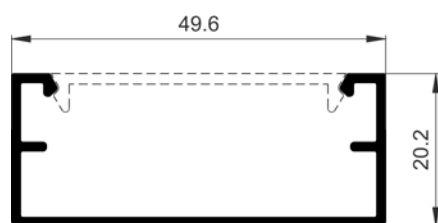

17698	
Descripción Description	Anclaje Anchoring
Peso Weight (g/m)	345,6
Superficie Surface (dm ² /m)	21,19
Ix (cm⁴)	0,68
Iy (cm⁴)	4,94
Tapas Covers	338502
Observaciones Observations	Con tapeta COR-8503. No apto para pasamanos. CONSULTAR DISPONIBILIDAD With COR-8503 end plate. Not valid for handrails. CHECK AVAILABILITY

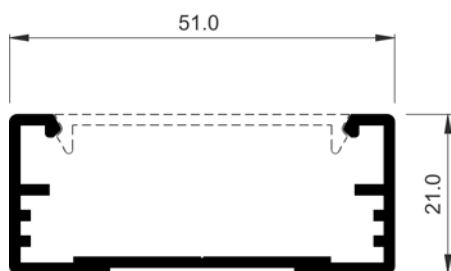

COR-8502	
Descripción Description	Anclaje pasamanos Handrail anchoring
Peso Weight (g/m)	461,7
Superficie Surface (dm ² /m)	23,79
Ix (cm⁴)	0,86
Iy (cm⁴)	6,81
Escuadra principal Main cleat	908506 908508 908511 908512
Tapas Covers	338502

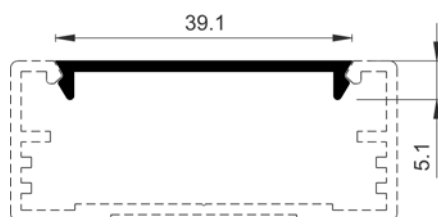

COR-8503	
Descripción Description	Tapeta anclaje Anchoring end plate
Peso Weight (g/m)	175,5
Superficie Surface (dm ² /m)	9,37
Ix (cm⁴)	0,01
Iy (cm⁴)	1,01

BARANDILLA CLASSIC
Perfiles a escala

CLASSIC BALUSTRADE
Profiles to scale

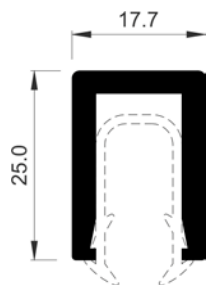
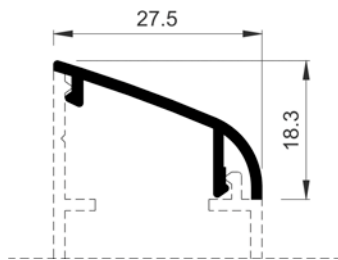
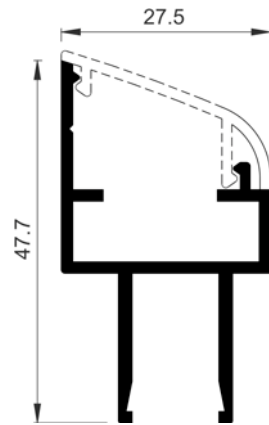
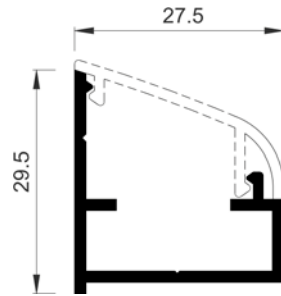

COR-8504	
Descripción Description	Portabarrotillo Baluster holder
Peso Weight (g/m)	321,3
Superficie Surface (dm ² /m)	16,31
Ix (cm⁴)	0,69
Iy (cm⁴)	1,34
Escuadra principal Main cleat	908507 908509
Observaciones Observations	Tapa COR-8506 COR-8506 cover

COR-8505	
Descripción Description	Portavidrio Glass holder
Peso Weight (g/m)	496,8
Superficie Surface (dm ² /m)	23,99
Ix (cm⁴)	2,21
Iy (cm⁴)	1,67
Escuadra principal Main cleat	908507 908509
Juntas Gaskets	908560
Observaciones Observations	Tapa COR-8506 Vidrio de espesor máximo 8 mm COR-8506 cover. Glass thickness 8 mm maximum

COR-8506	
Descripción Description	Tapa Cap
Peso Weight (g/m)	182,5
Superficie Surface (dm ² /m)	9,76
Ix (cm⁴)	0,17
Iy (cm⁴)	0,5
Observaciones Observations	Sobre perfiles COR- 8504/05 On profiles COR- 8504/05

COR-8511	
Descripción Description	Remate vidrio Glass finishing
Peso Weight (g/m)	513
Superficie Surface (dm ² /m)	13,19
Ix (cm⁴)	1,11
Iy (cm⁴)	0,87
Juntas Gaskets	908560
Observaciones Observations	Máximo acristalamiento de vidrio 8 mm Glass maximum glazing of 8 mm

BARANDILLA CLASSIC

Perfiles a escala

CLASSIC BALUSTRADE

Profiles to scale

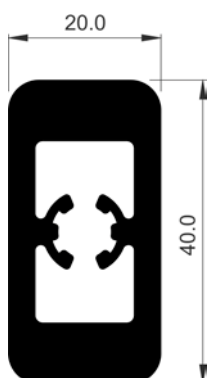

COR-8516	
Descripción Description	Pilastra Pilaster
Peso Weight (g/m)	1401,3
Superficie Surface (dm ² /m)	23,1
Ix (cm⁴)	8,71
Iy (cm⁴)	2,2
Observaciones Observations	Tornillo M8x30 DIN933-A2 M8x30 DIN933-A2 screw

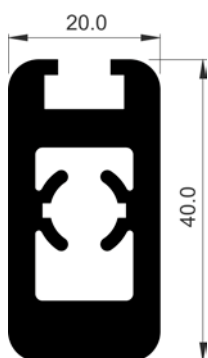

COR-8517	
Descripción Description	Pilastra para fijación recta Pilaster with straight fixation
Peso Weight (g/m)	1350
Superficie Surface (dm ² /m)	23,7
Ix (cm⁴)	7,43
Iy (cm⁴)	2,22
Observaciones Observations	Tornillo fijación COR- 8502 M10x30 DIN933-A2 Tornillo fijación COR-8504/05 M6x12 DIN933-A2 CONSULTAR DISPONIBILIDAD COR-8502 M10x30 DIN933-A2 clamping screw. COR-8504/05 M6x12 DIN933-A2 clamping screw. CHECK AVAILABILITY

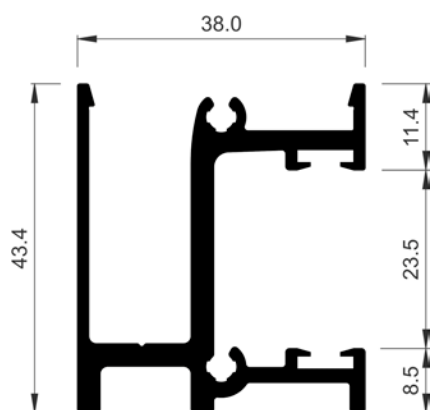

COR-8540	
Descripción Description	Soporte barandilla superpuesta Juliet balcony support
Peso Weight (g/m)	1012,5
Superficie Surface (dm ² /m)	34,51
Ix (cm⁴)	7,15
Iy (cm⁴)	5,04
Tapas Covers	358542
Tornillería Screws	814832
	824222
Observaciones Observations	Compatible con perfil Cor-1701 Compatible with profile Cor-1701

BARANDILLA CLASSIC

Perfiles a escala

CLASSIC BALUSTRADE

Profiles to scale

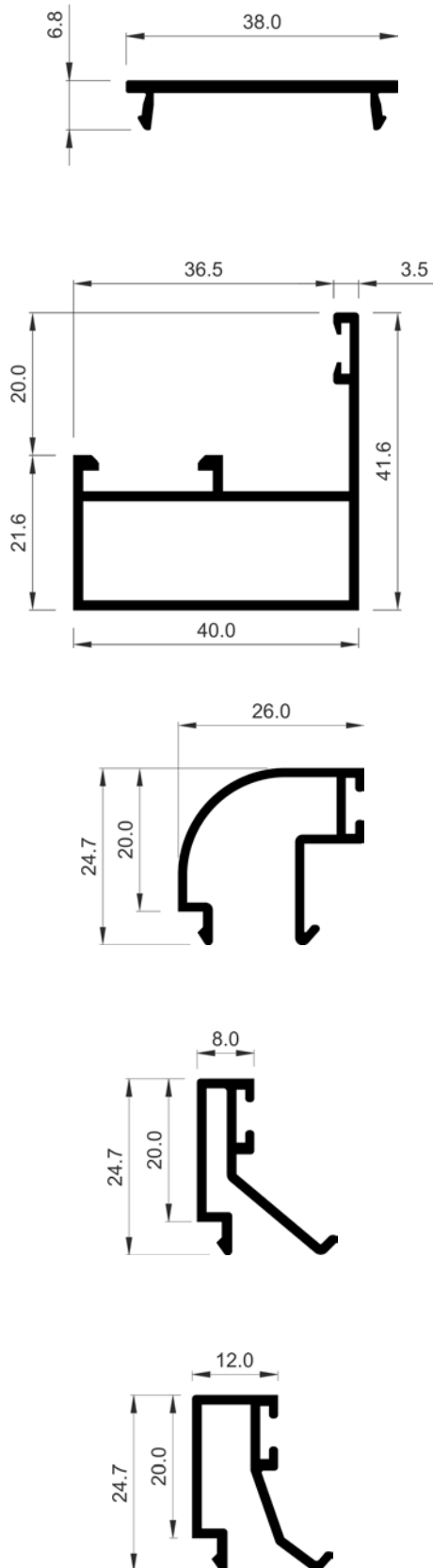

COR-1701	
Descripción Description	Tapa clipaje U refuerzo Reinforcement U-clip end plate
Peso Weight (g/m)	202,5
Superficie Surface (dm ² /m)	10
Ix (cm⁴)	0,02
Iy (cm⁴)	1,09

COR-2323	
Descripción Description	Marco para fijos sin soportes Frame for fixed lights without supports
Peso Weight (g/m)	542,7
Superficie Surface (dm ² /m)	30,73
Ix (cm⁴)	2,51
Iy (cm⁴)	4,41
Escuadra principal Main cleat	222396 920341

COR-2313	
Descripción Description	Junquillo curvo 26 mm Curve glazing bead 26 mm
Peso Weight (g/m)	278,1
Superficie Surface (dm ² /m)	16,99
Ix (cm⁴)	0,61
Iy (cm⁴)	0,76

COR-2093	
Descripción Description	Junquillo clip recto de 8 mm Straight glazing bead clip 8 mm
Peso Weight (g/m)	256,5
Superficie Surface (dm ² /m)	14,51
Ix (cm⁴)	0,56
Iy (cm⁴)	0,23

COR-2019	
Descripción Description	Junquillo clip recto de 12 mm Straight glazing bead clip 12 mm
Peso Weight (g/m)	261,9
Superficie Surface (dm ² /m)	14,77
Ix (cm⁴)	0,61
Iy (cm⁴)	0,27

BARANDILLA CLASSIC

Perfiles a escala

CLASSIC BALUSTRADE

Profiles to scale

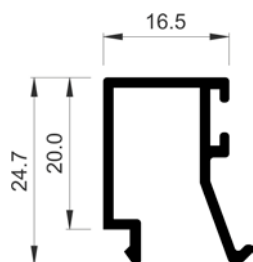

COR-2065	
Descripción Description	Junquillo clip recto de 16.50 mm Straight glazing bead clip 16,50 mm
Peso Weight (g/m)	270
Superficie Surface (dm ² /m)	15,13
Ix (cm⁴)	0,65
Iy (cm⁴)	0,41

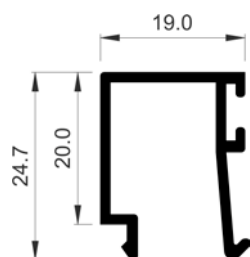

COR-2018	
Descripción Description	Junquillo clip recto de 19 mm Straight glazing bead clip 19 mm
Peso Weight (g/m)	275,4
Superficie Surface (dm ² /m)	15,52
Ix (cm⁴)	0,67
Iy (cm⁴)	0,53

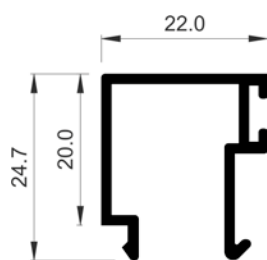

COR-2117	
Descripción Description	Junquillo clip recto de 22 mm Straight glazing bead clip 22 mm
Peso Weight (g/m)	294,3
Superficie Surface (dm ² /m)	16,44
Ix (cm⁴)	0,7
Iy (cm⁴)	0,69

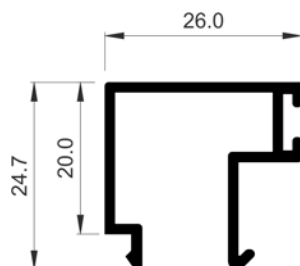

COR-2015	
Descripción Description	Junquillo clip recto de 26 mm Straight glazing bead clip 26 mm
Peso Weight (g/m)	321,3
Superficie Surface (dm ² /m)	18,04
Ix (cm⁴)	0,75
Iy (cm⁴)	0,97

aluminiosiberica.pai.pt



Aluminios Iberica, Lda

Sede e Fábrica: Rua parque Industrial, Nº 126
4720-536 Lago Amareos
Telef. 253 310 250 / 253 310 251 Fax. 253 311 830
Email: geral@aluminiosiberica.pt

Filiais:

Vila Real Lugar de Couços – EN 115
5000-122 Justes – Vila Real
Telef. 259 331 778 / Fax. 259 928 092
Email: vreal@aluminiosiberica.pt



EXEMPLO CONCRETO
Painéis Sandwich - Perfis - Chapas - Remates - Acessórios

Vila Nova de Gaia (Exemplo Concreto, LDA)
Rua Nova de São Caetano, nº3
4405-819 Vilar do Paraíso
Telef. 227 629 539
Email: gaia@exemploconcreto.com



Armazém: Est. Do Campo de Aviação
3510-824 Campo – Viseu
Telef. 232 459 138 / 232 459 741
Fax. 232 450 140
Email: geral@alviz.pt



Armazém: Zona Industrial de Vilamoura
Lote 28 - Apartado 841
8126 -910 Quarteira
Telef. 289 322 748 Fax. 289 301 928
Email: pala.loule@sapo.pt



Armazém: Av. Almirante Gago Coutinho
Portela de Sintra - Apartado 212
2711 - 901 Sintra
Telef. 219 244 074 / 219 244 101 Fax. 219 241 015
Email: angularlda@sapo.pt