

Aluminios Iberica, Lda



PALA - MIGUEL & REIS, LDA.



EXEMPLO CONCRETO

Painéis Sandwich - Perfis - Chapas - Remates - Acessórios



ALUMÍNIOS DE VISEU, LDA.



ANGULAR - Alumínios, Lda.







Catálogo **PERFIS Diversos**

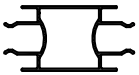

PERFIS DIVERSOS

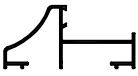
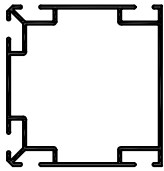
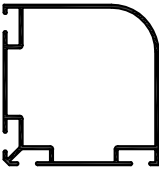
PERFIS COMPLEMENTARES









LISTA DE PERFIS

Perfil	Ref.	Designação	P. Teórico (kg/m)	Área Trat. / Poli. (m / m)	Mom. Ix / Iy (cm ⁴)
	TD 01	PERFIL PARA DIVISÓRIAS	0.88	0.35 / 0.10	4.8 / 11.0
	TD 02	PERFIL PARA DIVISÓRIAS	0.19	0.12 / 0.04	0.02 / 7.1
	TD 03	PERFIL PARA DIVISÓRIAS	0.53	0.34 / 0.07	1.5 / 9.0
	TD 05	PERFIL PARA DIVISÓRIAS	2.09	0.55 / 0.25	77.8 / 71.4
	TD 04	PERFIL PARA DIVISÓRIAS	1.88	0.47 / 0.26	60.8 / 71.9
	TAF2001/A	PERFIL DE SINALIZAÇÃO	1.97	0.64 / 0.17	12.9 / 298.3
	TAF2001/B	PERFIL DE SINALIZAÇÃO	1.86	0.66 / 0.17	13.5 / 291.6
	TAF 2002	PERFIL DE SINALIZAÇÃO	2.50	0.17 / 0	2.7/ 33.3

PERFIS DIVERSOS

PERFIS COMPLEMENTARES

LISTA DE PERFIS

Perfil	Ref.	Designação	P. Teórico (kg/m)	Área Trat. / Poli. (m / m)	Mom. Ix / Iy (cm ⁴)
	TAF 2003	PERFIL DE SINALIZAÇÃO	4.82	0.43 / 0.0	369.7 / 33.4
	TAF 2004	PERFIL DE SINALIZAÇÃO	8.08	0.72 / 0.0	111.2 / 1112
	T10	PERFIL DE SINALIZAÇÃO	0.57	0.19 / 0.0	1.0 / 2.9
	T11	PERFIL DE SINALIZAÇÃO	1.22	0.34 / 0.16	1.7 / 65.8
	T12	PERFIL DE SINALIZAÇÃO	0.21	0.07 / 0.04	0.1 / 0.4
	T13	PERFIL DE SINALIZAÇÃO	0.37	0.13 / 0.0	0.3 / 1.2
	TV 1006	PERFIL TECTOS FALSOS	0.40	0.19 / 0.09	0.6 / 4.8
	TV 1009	PERFIL TECTOS FALSOS	0.43	0.21 / 0.08	0.3 / 6.9
	TV 1011	PERFIL TECTOS FALSOS	0.37	0.24 / 0.08	0.2 / 10.4

PERFIS DIVERSOS

PERFIS COMPLEMENTARES

PERFIS PARA DIVISÓRIAS

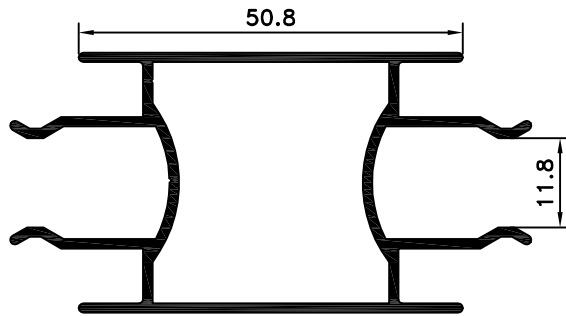

Perfil	P. Teórico	Área Trat./Poli.
TD 01	0.88 kg/m	350/100 m/m

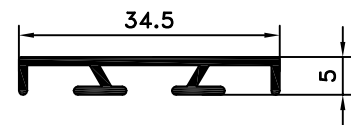

Perfil	P. Teórico	Área Trat./Poli.
TD 02	0.19 kg/m	120/40 m/m

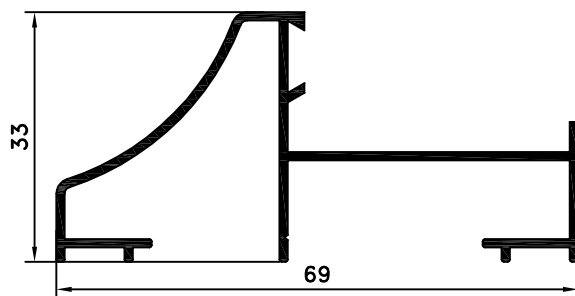

Perfil	P. Teórico	Área Trat./Poli.
TD 03	0.53 kg/m	340/70 m/m

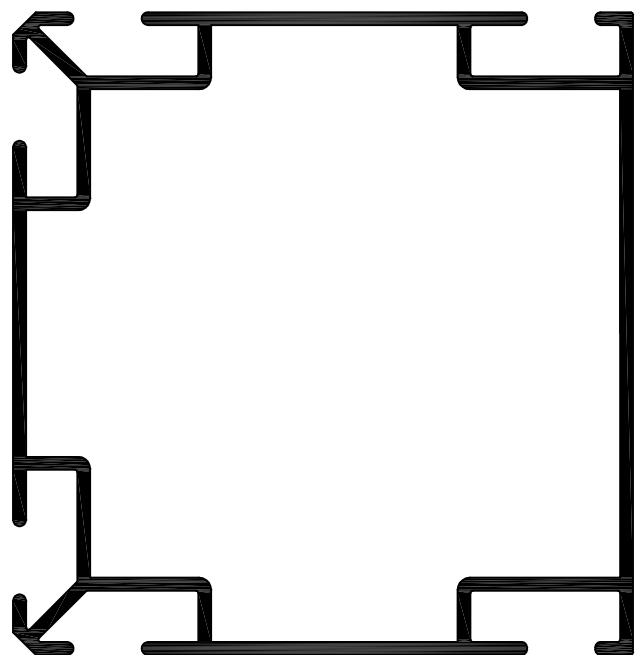

Perfil	P. Teórico	Área Trat./Poli.
TD 05	2.09 kg/m	550/250 m/m

PERFIS DIVERSOS

PERFIS COMPLEMENTARES

PERFIS PARA DIVISÓRIAS

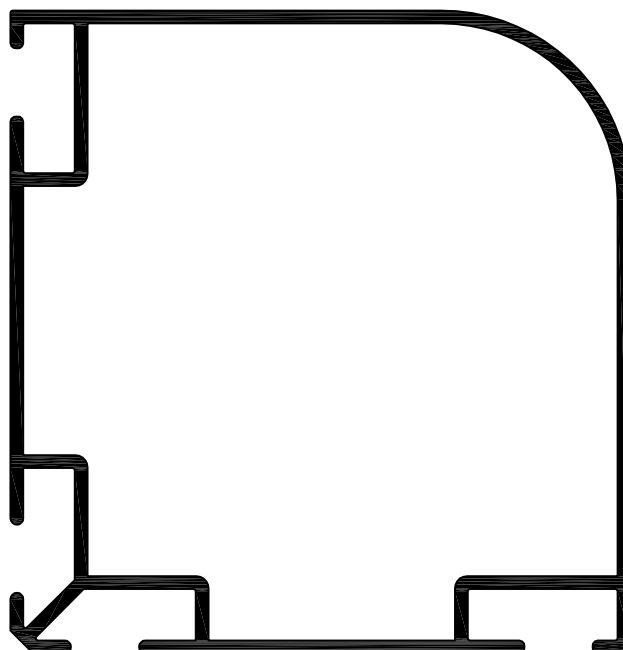

Perfil	P. Teórico	Área Trat./Poli.
TD 04	1.88 kg/m	470/260 m/m

PERFIS PARA SINALIZAÇÃO



Perfil	P. Teórico	Área Trat./Poli.
TAF 2003	4.82 kg/m	430/0 m/m

PERFIS PARA SINALIZAÇÃO



Perfil	P. Teórico	Área Trat./Poli.
TAF 2001A	1.97 kg/m	640/170 m/m

Perfil	P. Teórico	Área Trat./Poli.
TAF 2001B	1.86 kg/m	660/170 m/m

PERFIS DIVERSOS

PERFIS COMPLEMENTARES

PERFIS PARA SINALIZAÇÃO

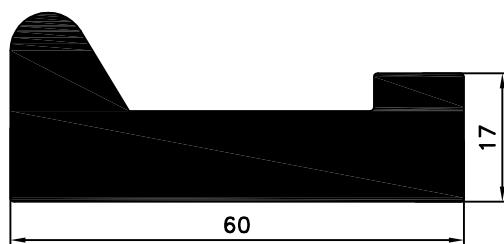

Perfil	P. Teórico	Área Trat./Poli.
TAF 2002	1.86 kg/m	660/170 m/m

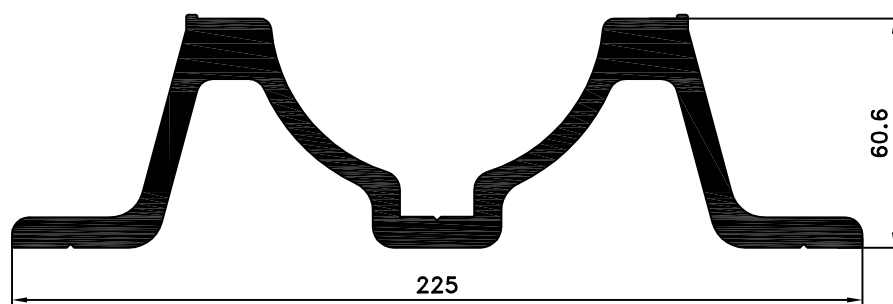

Perfil	P. Teórico	Área Trat./Poli.
TAF 2004	8.08 kg/m	720/0 m/m

ESCALA 1:2

PERFIS DIVERSOS

PERFIS COMPLEMENTARES

PERFIS PARA SINALIZAÇÃO

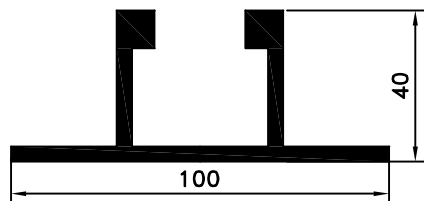

Perfil	P. Teórico	Área Trat./Poli.
T 10	0.57 kg/m	190/0 m/m

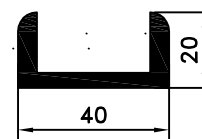

Perfil	P. Teórico	Área Trat./Poli.
T 12	0.21 kg/m	70/40 m/m

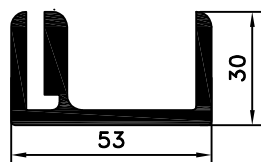

Perfil	P. Teórico	Área Trat./Poli.
T 13	0.37 kg/m	130/0 m/m

PERFIS DIVERSOS

PERFIS COMPLEMENTARES

PERFIS PARA SINALIZAÇÃO

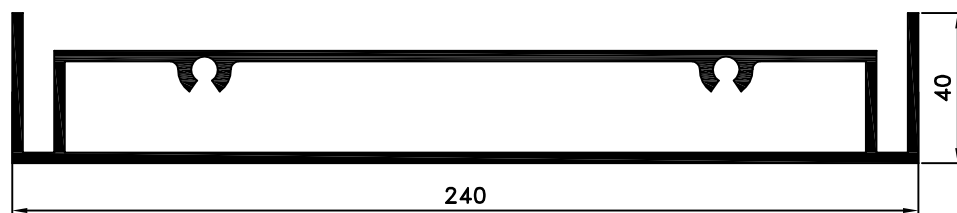

Perfil	P. Teórico	Área Trat./Poli.
T 11	1.22 kg/m	340/160 m/m

PERFIS PARA TECTOS FALSOS

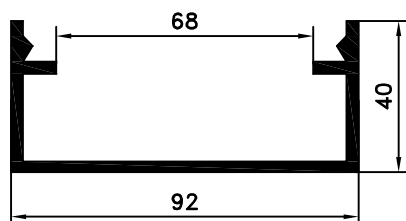

Perfil	P. Teórico	Área Trat./Poli.
TV 1006	0.37 kg/m	130/0 m/m

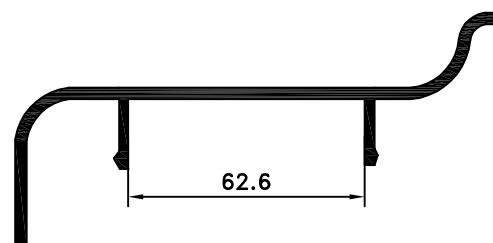

Perfil	P. Teórico	Área Trat./Poli.
TV 1009	0.43 kg/m	210/80 m/m

PERFIS DIVERSOS

PERFIS COMPLEMENTARES

PERFIS PARA TECTOS FALSOS

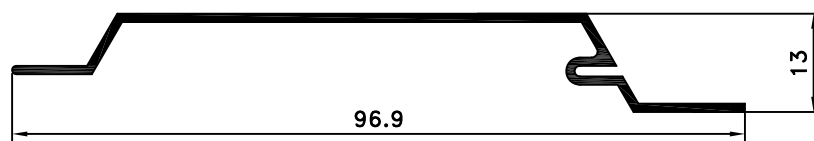

Perfil	P. Teórico	Área Trat./Poli.
TV 1011	0,37 kg/m	240/80 m/m



Esquema de Montagem de Divisórias

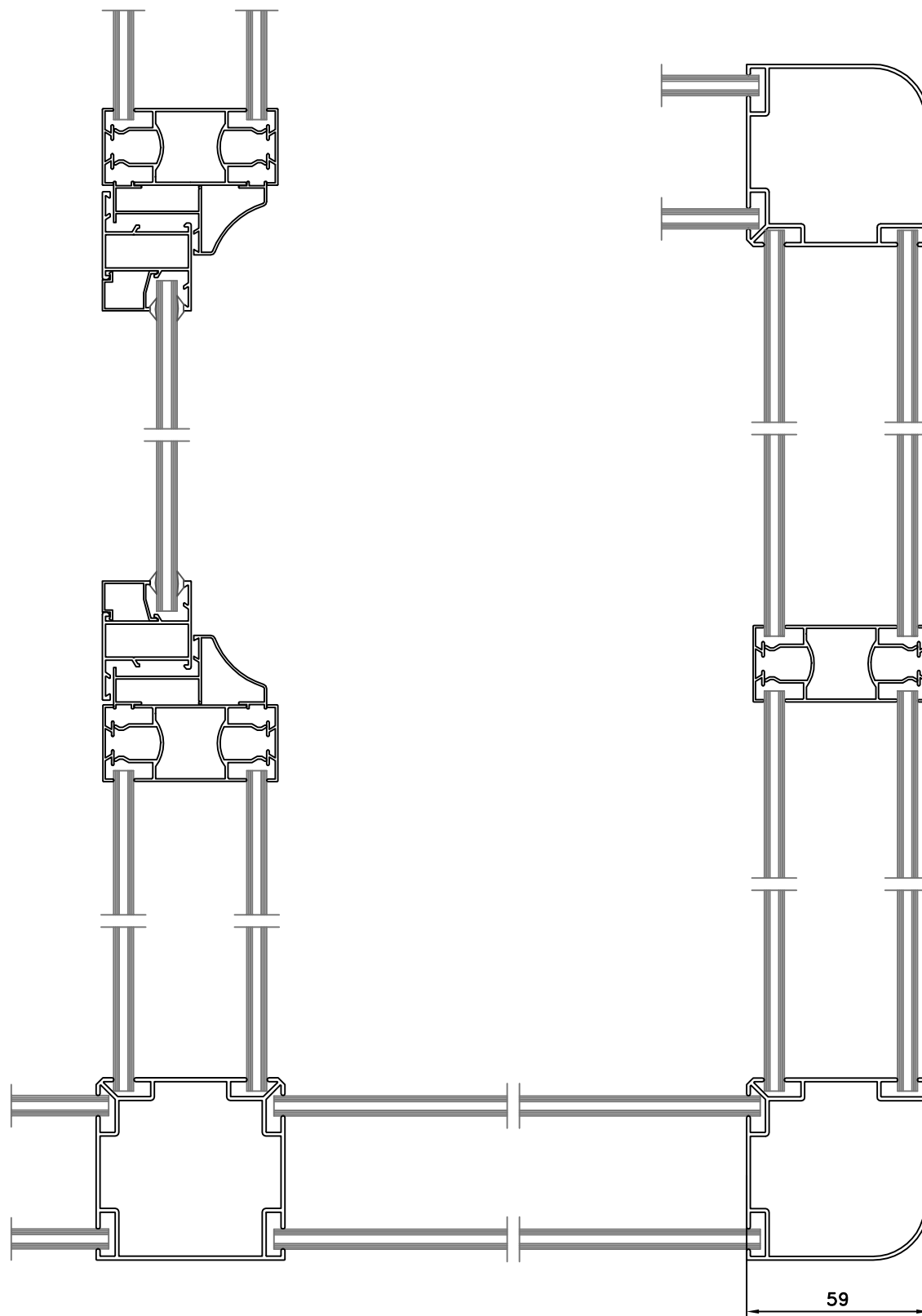

Esquema de Montagem de Tectos Falsos

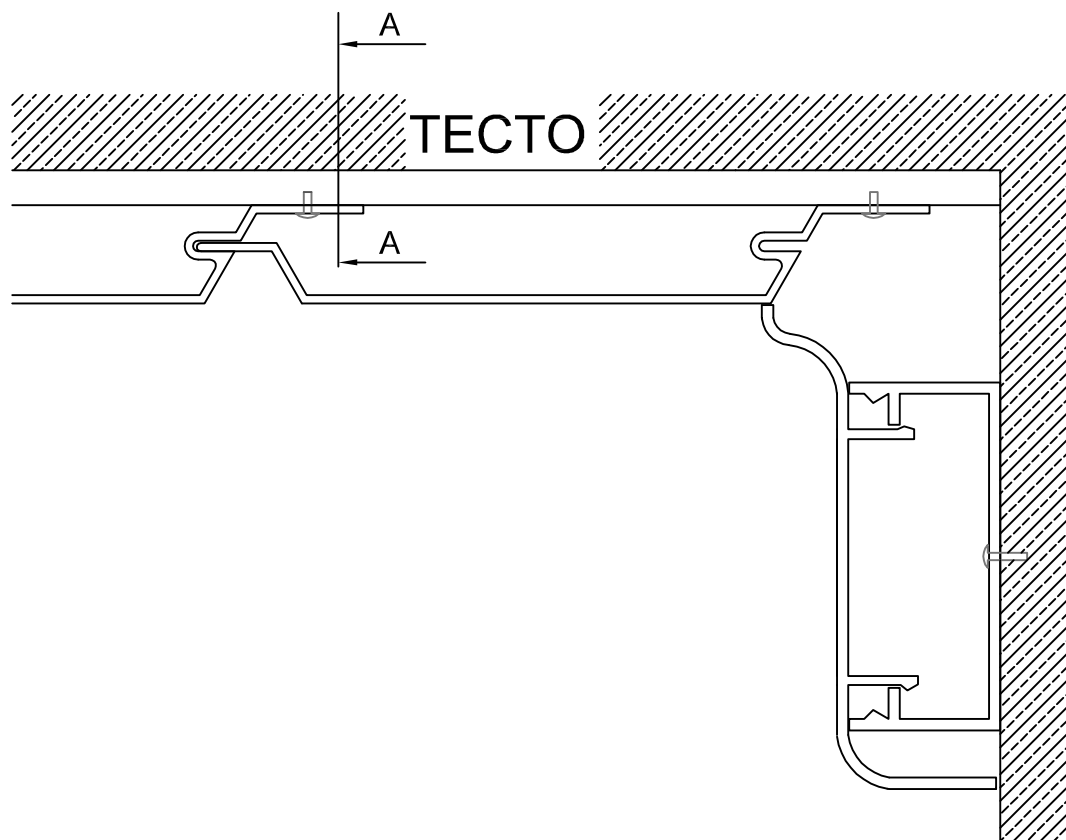

CORTE A:A

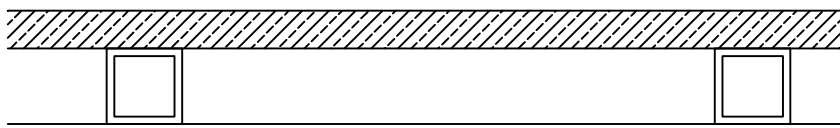

aluminiosiberica.pai.pt



Aluminios Iberica, Lda

Sede e Fábrica: Rua parque Industrial, Nº 126
4720-536 Lago Amares
Telef. 253 310 250 / 253 310 251 Fax. 253 311 830
Email: geral@aluminiosiberica.pt

Filiais:

Vila Real Lugar de Couços – EN 115
5000-122 Justes – Vila Real
Telef. 259 331 778 / Fax. 259 928 092
Email: vreal@aluminiosiberica.pt



EXEMPLO CONCRETO
Painéis Sandwich - Perfis - Chapas - Remates - Acessórios

Vila Nova de Gaia (Exemplo Concreto, LDA)
Rua Nova de São Caetano, nº3
4405-819 Vilar do Paraíso
Telef. 227 629 539
Email: gaia@exemploconcreto.com



ALUMÍNIOS DE VISEU, LDA.

Armazém: Est. Do Campo de Aviação
3510-824 Campo – Viseu
Telef. 232 459 138 / 232 459 741
Fax. 232 450 140
Email: geral@alviz.pt



PALA - MIGUEL & REIS, LDA.

Armazém: Zona Industrial de Vilamoura
Lote 28 - Apartado 841
8126 -910 Quarteira
Telef. 289 322 748 Fax. 289 301 928
Email: pala.loule@sapo.pt



ANGULAR - Aluminios, Lda

Armazém: Av. Almirante Gago Coutinho
Portela de Sintra - Apartado 212
2711 - 901 Sintra
Telef. 219 244 074 / 219 244 101 Fax. 219 241 015
Email: angularlda@sapo.pt