



Aluminios Iberica, Lda



PALA - MIGUEL & REIS, LDA.



EXEMPLO CONCRETO

Painéis Sandwich - Perfis - Chapas - Remates - Acessórios



ALUMÍNIOS DE VISEU, LDA.



ANGULAR - Alumínios, Lda.

Catálogo Division Oficinas PW80



DIVISION DE OFICINAS PW 80
Perfiles a escala

PW 80 OFFICE PARTITION WALL
Profiles to scale

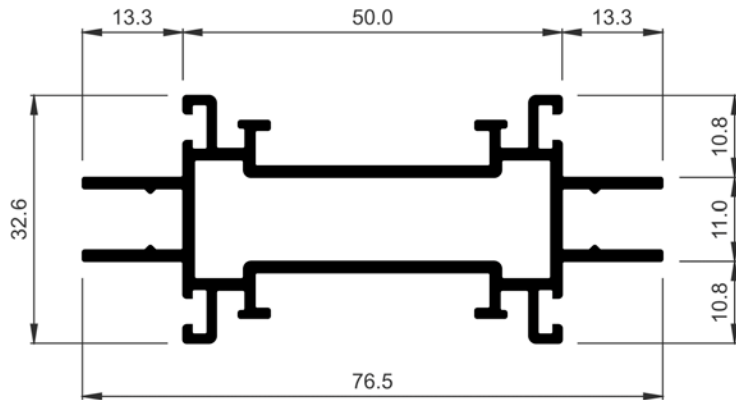

COR-2525	
Descripción Description	Montante principal Main mullion
Peso Weight (g/m)	1034,1
Superficie Surface (dm ² /m)	52,64
Ix (cm ⁴)	2,66
Iy (cm ⁴)	18,19
Escuadra principal Main cleat	412525

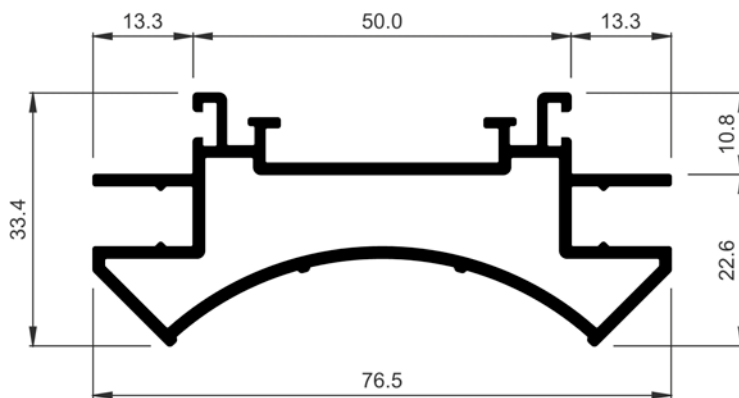

COR-2526	
Descripción Description	Montante regulable Adjustable mullion
Peso Weight (g/m)	1044,9
Superficie Surface (dm ² /m)	52,08
Ix (cm ⁴)	2,82
Iy (cm ⁴)	21,81
Escuadra principal Main cleat	412525

DIVISION DE OFICINAS PW 80
Perfiles a escala

PW 80 OFFICE PARTITION WALL
Profiles to scale

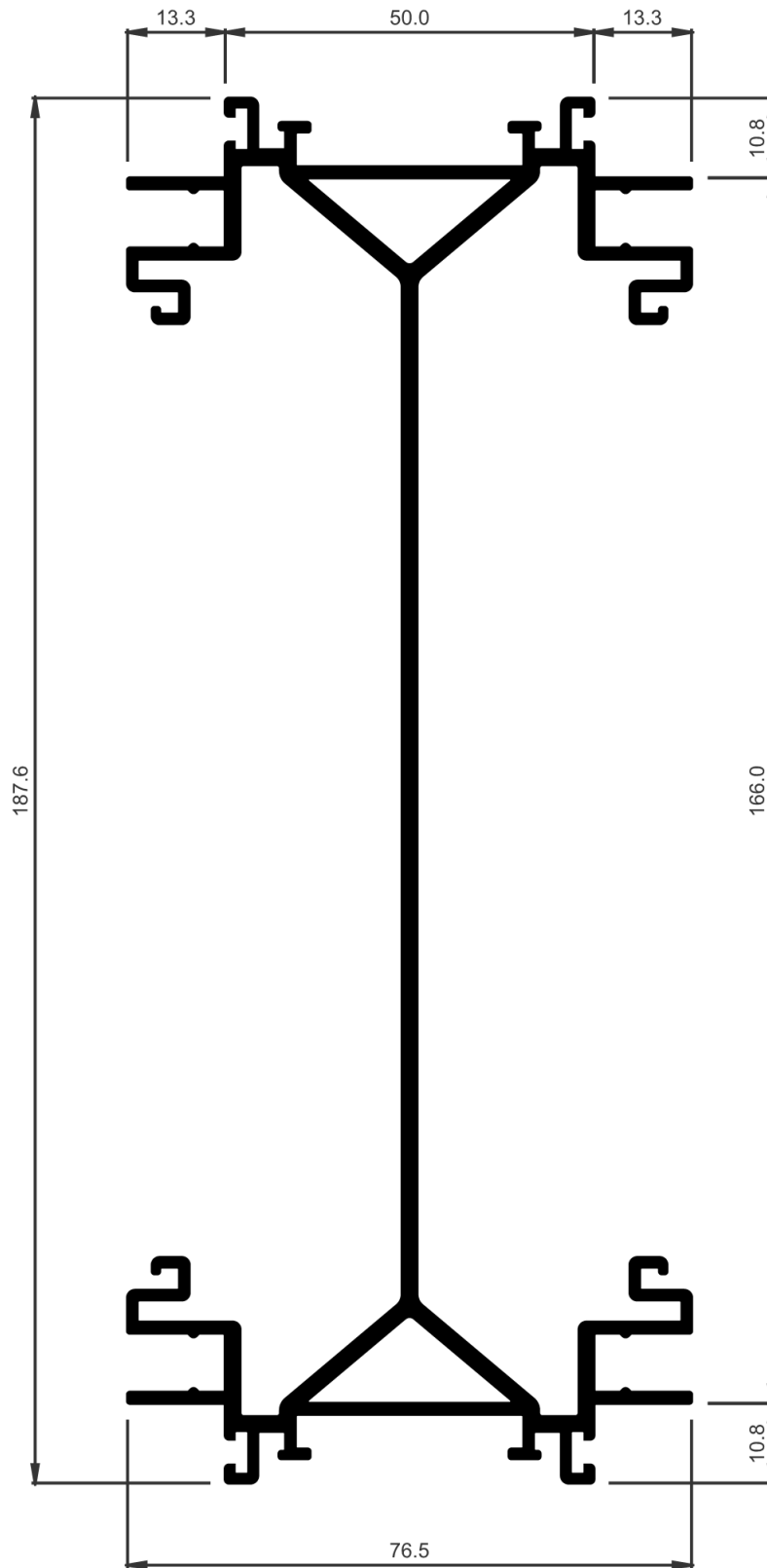

COR-2528	
Descripción Description	Montante de instalaciones Mullion of installation
Peso Weight (g/m)	2805,3
Superficie Surface (dm ² /m)	129,88
Ix (cm ⁴)	475,51
Iy (cm ⁴)	40,2
Escuadra principal Main cleat	412525
Observaciones Observations	CONSULTAR DISPONIBILIDAD CHECK AVAILABILITY

DIVISION DE OFICINAS PW 80
Perfiles a escala

PW 80 OFFICE PARTITION WALL
Profiles to scale

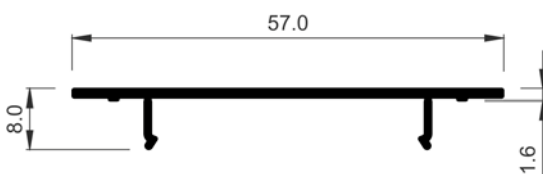
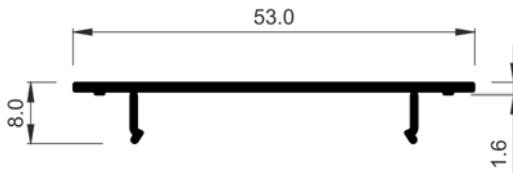
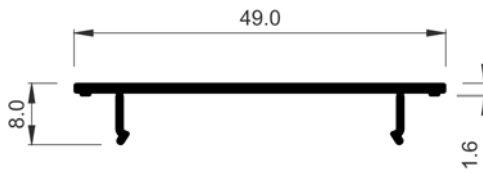
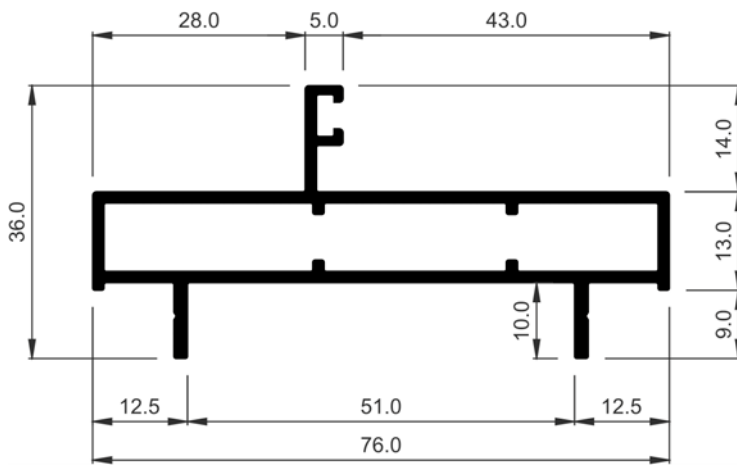
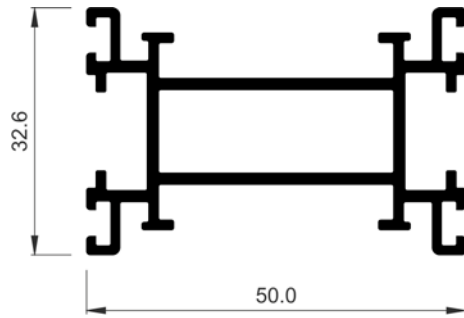

COR-2527	
Descripción Description	Rigidizador de panel Panel stiffeners
Peso Weight (g/m)	818,1
Superficie Surface (dm ² /m)	42,27
Ix (cm ⁴)	2,48
Iy (cm ⁴)	8,91
Escuadra principal Main cleat	412525
Observaciones Observations	CONSULTAR DISPONIBILIDAD CHECK AVAILABILITY

COR-2531	
Descripción Description	Marco de puerta Door frame
Peso Weight (g/m)	901,8
Superficie Surface (dm ² /m)	43,56
Ix (cm ⁴)	1,81
Iy (cm ⁴)	17,99
Escuadra principal Main cleat	248220
Troquel Punch tool	347799
Juntas Gaskets	222401

COR-2510	
Descripción Description	Tapa 49 mm Cover 49 mm
Peso Weight (g/m)	213,3
Superficie Surface (dm ² /m)	12,86
Ix (cm ⁴)	0,03
Iy (cm ⁴)	1,79

COR-2511	
Descripción Description	Tapa 53 mm Cover 53 mm
Peso Weight (g/m)	226,8
Superficie Surface (dm ² /m)	13,66
Ix (cm ⁴)	0,03
Iy (cm ⁴)	2,13

COR-2512	
Descripción Description	Tapa 57 mm Cover 57 mm
Peso Weight (g/m)	240,3
Superficie Surface (dm ² /m)	14,46
Ix (cm ⁴)	0,03
Iy (cm ⁴)	2,52

DIVISION DE OFICINAS PW 80
Perfiles a escala

PW 80 OFFICE PARTITION WALL
Profiles to scale

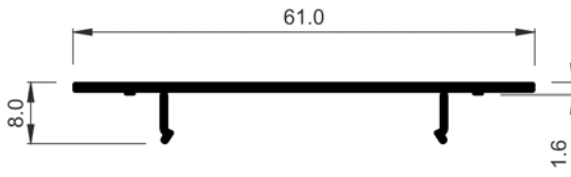

COR-2513	
Descripción Description	Tapa 61 mm Cover 61 mm
Peso Weight (g/m)	253,8
Superficie Surface (dm ² /m)	15,26
Ix (cm ⁴)	0,03
Iy (cm ⁴)	2,97

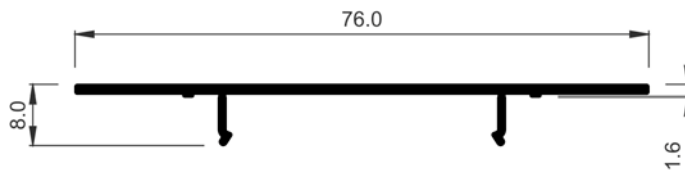

COR-2516	
Descripción Description	Tapa 76 mm Cover 76 mm
Peso Weight (g/m)	307,8
Superficie Surface (dm ² /m)	18,26
Ix (cm ⁴)	0,03
Iy (cm ⁴)	5,26

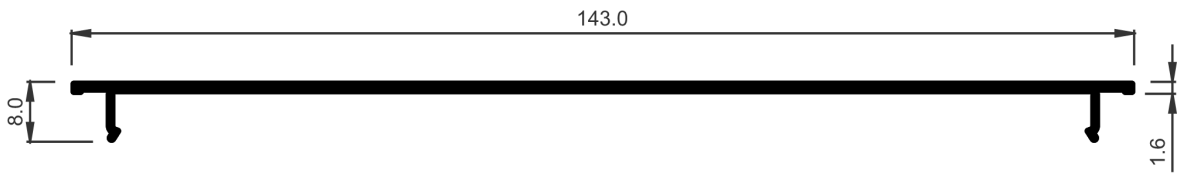

COR-2518	
Descripción Description	Tapa 143 mm Cover 143 mm
Peso Weight (g/m)	612,9
Superficie Surface (dm ² /m)	31,65
Ix (cm ⁴)	0,03
Iy (cm ⁴)	42
Observaciones Observations	CONSULTAR DISPONIBILIDAD CHECK AVAILABILITY

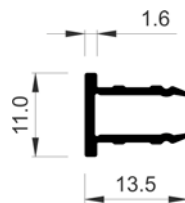

COR-2500	
Descripción Description	Tapeta 11 mm Cover 11 mm
Peso Weight (g/m)	110,7
Superficie Surface (dm ² /m)	7,31
Ix (cm ⁴)	0,04
Iy (cm ⁴)	0,07

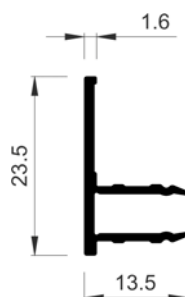

COR-2501	
Descripción Description	Tapeta 23,5 mm Cover 23,5 mm
Peso Weight (g/m)	153,9
Superficie Surface (dm ² /m)	9,85
Ix (cm ⁴)	0,23
Iy (cm ⁴)	0,09
Juntas Gaskets	412500

DIVISION DE OFICINAS PW 80
Perfiles a escala

PW 80 OFFICE PARTITION WALL
Profiles to scale

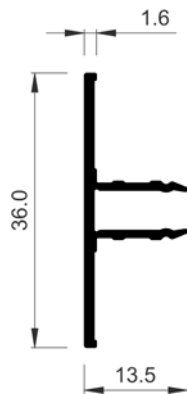

COR-2502	
Descripción Description	Tapeta 36 mm Cover 36 mm
Peso Weight (g/m)	199,8
Superficie Surface (dm ² /m)	12,39
Ix (cm ⁴)	0,55
Iy (cm ⁴)	0,1
Juntas Gaskets	412500

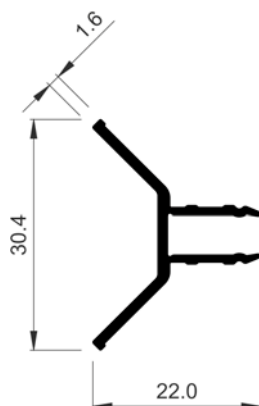

COR-2503	
Descripción Description	Tapeta 45° 30.4 mm Cover 45° 30.4 mm
Peso Weight (g/m)	199,8
Superficie Surface (dm ² /m)	12,46
Ix (cm ⁴)	0,41
Iy (cm ⁴)	0,23
Juntas Gaskets	412500
Observaciones Observations	CONSULTAR DISPONIBILIDAD CHECK AVAILABILITY

DIVISION DE OFICINAS PW 80
Perfiles a escala

PW 80 OFFICE PARTITION WALL
Profiles to scale

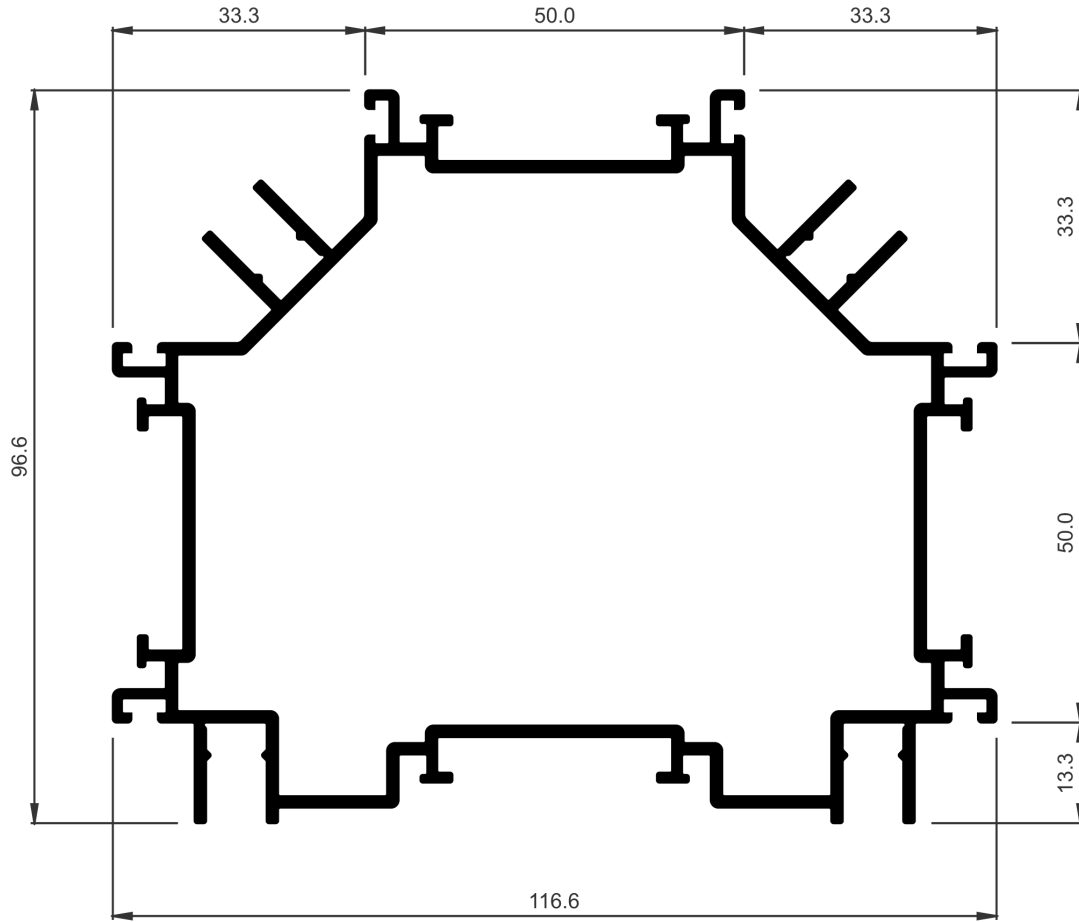

COR-2540	
Descripción Description	Montante esquinero tres salidas Three outputs corner profile mullion
Peso Weight (g/m)	2322
Superficie Surface (dm ² /m)	117,09
Ix (cm ⁴)	88,65
Iy (cm ⁴)	125,29
Escuadra principal Main cleat	412525
Observaciones Observations	CONSULTAR DISPONIBILIDAD CHECK AVAILABILITY

DIVISION DE OFICINAS PW 80
Perfiles a escala

PW 80 OFFICE PARTITION WALL
Profiles to scale

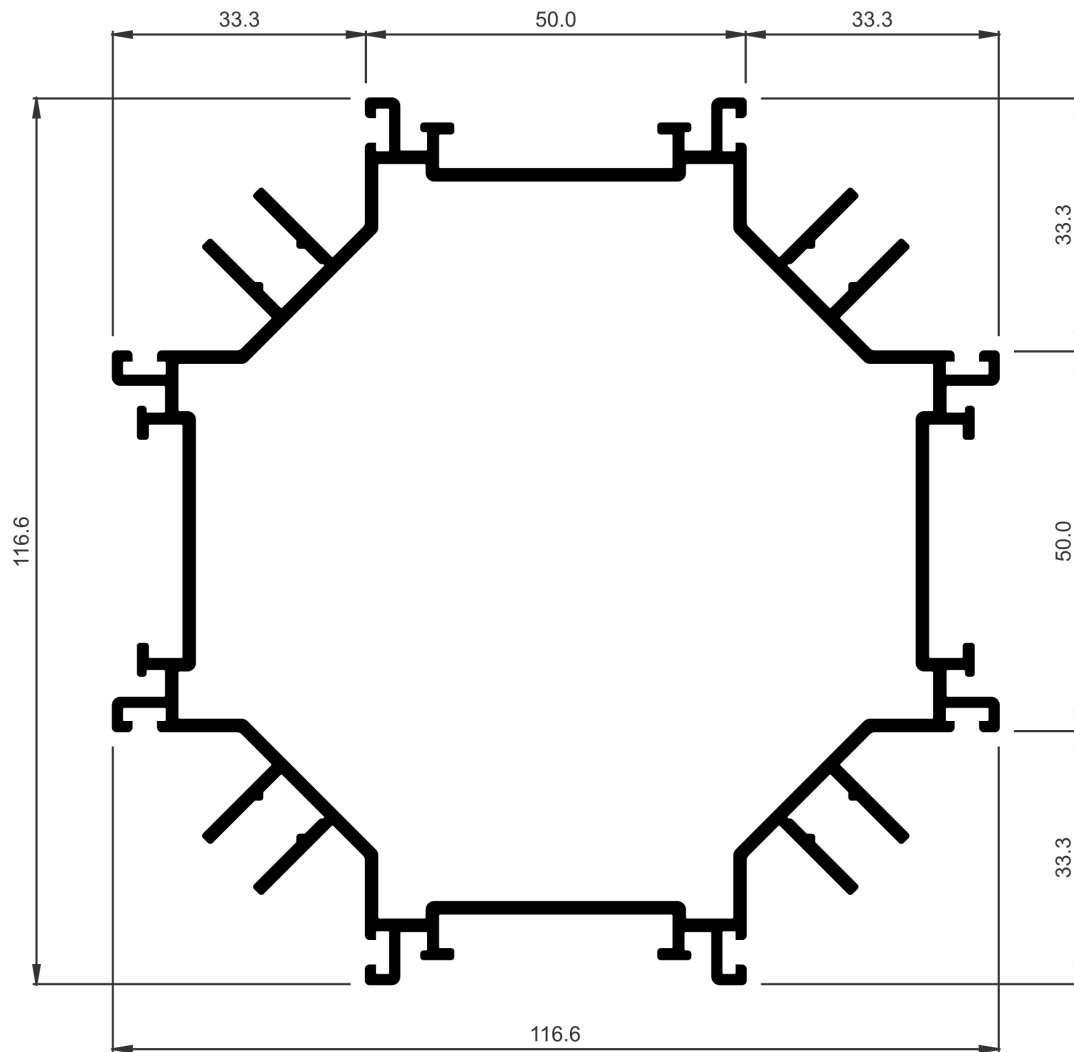

COR-2541

Descripción Description	Montante esquinero cuatro salidas Four outputs corner profile mullion
Peso Weight (g/m)	2478,6
Superficie Surface (dm ² /m)	125,8
Ix (cm ⁴)	127,15
Iy (cm ⁴)	127,18
Escuadra principal Main cleat	412525
Observaciones Observations	CONSULTAR DISPONIBILIDAD CHECK AVAILABILITY

DIVISION DE OFICINAS PW 80
Perfiles a escala

PW 80 OFFICE PARTITION WALL
Profiles to scale

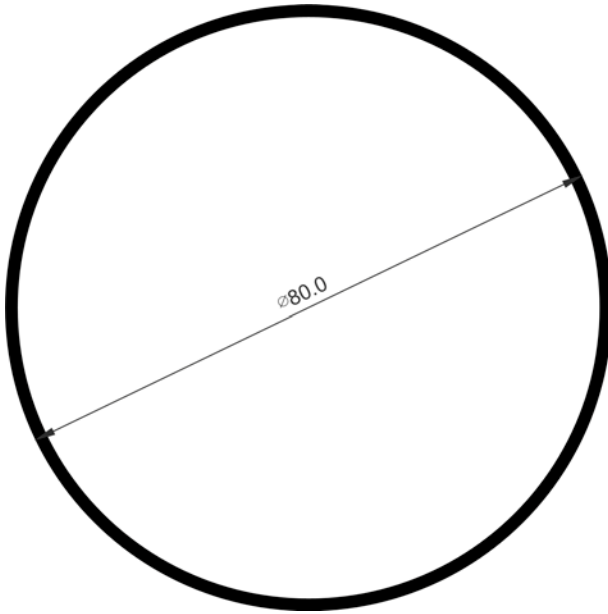

800080	
Descripción Description	Tubo redondo de 80 mm (80x77x1.50) Round tube 80 mm (50x46x2)
Peso Weight (g/m)	999
Superficie Surface (dm ² /m)	49,33
Ix (cm⁴)	28,5
Iy (cm⁴)	28,5

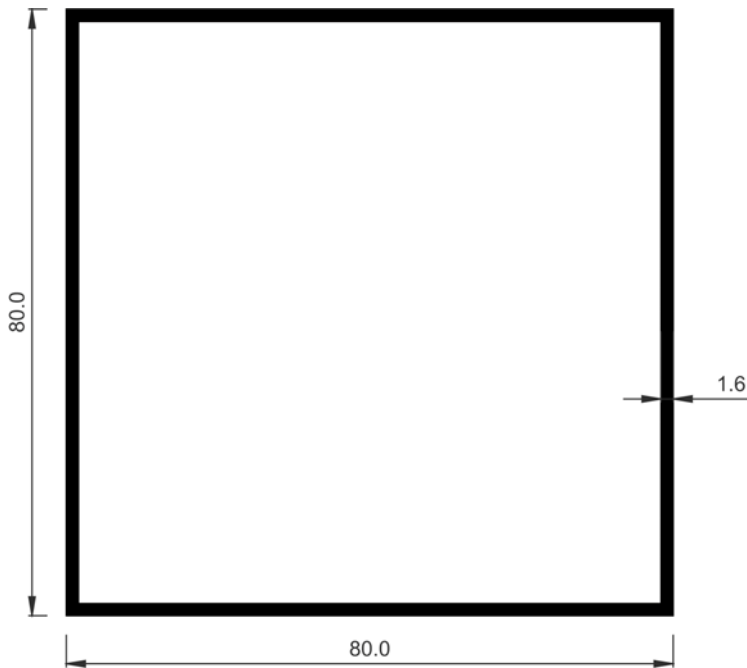

808080	
Descripción Description	Tubo de 80x80x1.6 mm 80x80x1.6 mm tube
Peso Weight (g/m)	1355,4
Superficie Surface (dm ² /m)	62,72
Ix (cm⁴)	51,42
Iy (cm⁴)	51,42

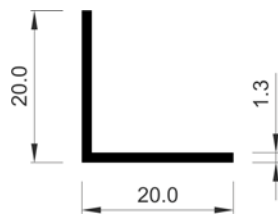

702020	
Descripción Description	Ángulo de 20x20x1.3 mm 20x20x1.3mm angle
Peso Weight (g/m)	137,7
Superficie Surface (dm ² /m)	8
Ix (cm⁴)	1,97
Iy (cm⁴)	1,97

DIVISION DE OFICINAS PW 80
Perfiles a escala

PW 80 OFFICE PARTITION WALL
Profiles to scale

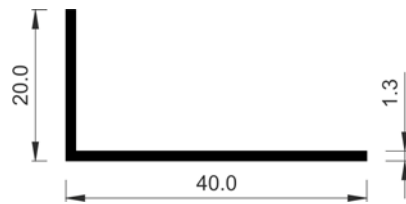

704020	
Descripción Description	Ángulo de 40x20x1.3 mm 40x20x1.3 mm angle
Peso Weight (g/m)	207,9
Superficie Surface (dm ² /m)	12
Ix (cm ⁴)	0,24
Iy (cm ⁴)	1,31

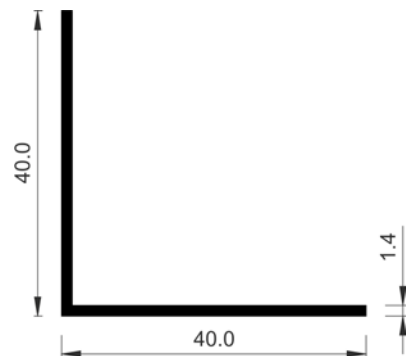

704040	
Descripción Description	Ángulo de 40x40x1.4 mm 40x40x1.4 mm angle
Peso Weight (g/m)	299,7
Superficie Surface (dm ² /m)	16
Ix (cm ⁴)	1,77
Iy (cm ⁴)	1,77

aluminiosiberica.pai.pt



Aluminios Iberica, Lda

Sede e Fábrica: Rua parque Industrial, Nº 126
4720-536 Lago Amares
Telef. 253 310 250 / 253 310 251 Fax. 253 311 830
Email: geral@aluminiosiberica.pt

Filiais:

Vila Real Lugar de Couços – EN 115
5000-122 Justes – Vila Real
Telef. 259 331 778 / Fax. 259 928 092
Email: vreal@aluminiosiberica.pt



EXEMPLO CONCRETO
Painéis Sandwich - Perfis - Chapas - Remates - Acessórios

Vila Nova de Gaia (Exemplo Concreto, LDA)
Rua Nova de São Caetano, nº3
4405-819 Vilar do Paraíso
Telef. 227 629 539
Email: gaia@exemploconcreto.com



Armazém: Est. Do Campo de Aviação
3510-824 Campo – Viseu
Telef. 232 459 138 / 232 459 741
Fax. 232 450 140
Email: geral@alviz.pt



Armazém: Zona Industrial de Vilamoura
Lote 28 - Apartado 841
8126 -910 Quarteira
Telef. 289 322 748 Fax. 289 301 928
Email: pala.loule@sapo.pt



Armazém: Av. Almirante Gago Coutinho
Portela de Sintra - Apartado 212
2711 - 901 Sintra
Telef. 219 244 074 / 219 244 101 Fax. 219 241 015
Email: angularlda@sapo.pt