



Aluminios Iberica, Lda



PALA - MIGUEL & REIS, LDA.



EXEMPLO CONCRETO

Painéis Sandwich - Perfis - Chapas - Remates - Acessórios



ALUMÍNIOS DE VISEU, LDA.



ANGULAR - Alumínios, Lda.

Catálogo ~~BVM~~ Standard



SÉRIE DE PERFIS - PS
Perfis à escala

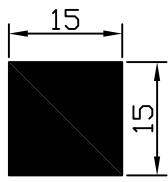

PS 2001

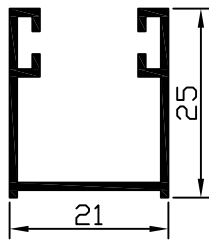

PS 2006

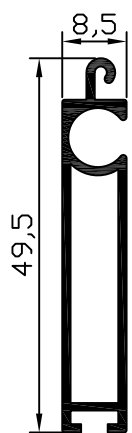

PS 2007

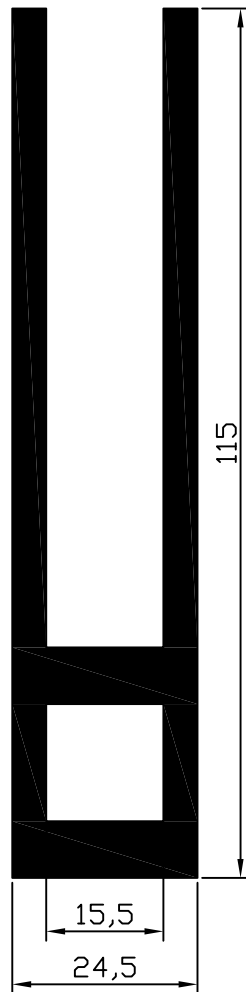

PS 2010

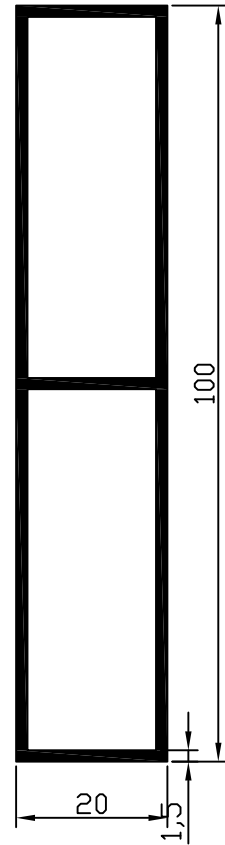

PS 2011

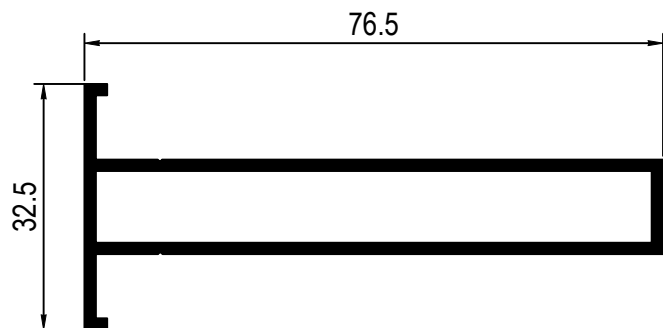

PS 2012

SÉRIE DE PERFIS - PS
Perfis à escala

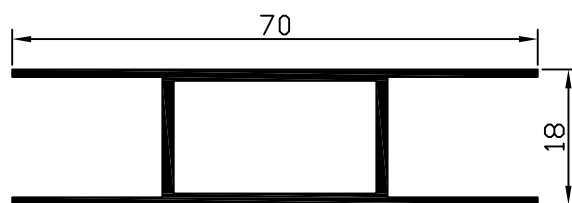

PS 2013

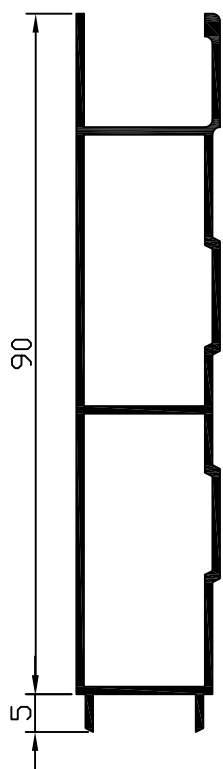

PS 2019

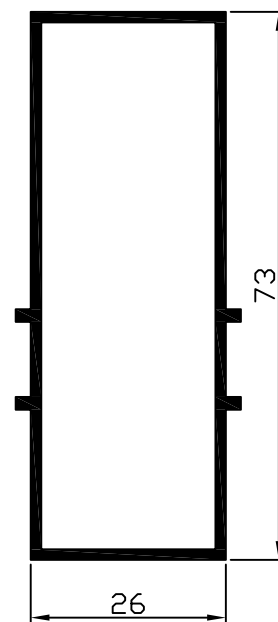

PS 2018

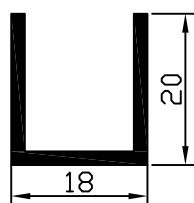

PS 2021

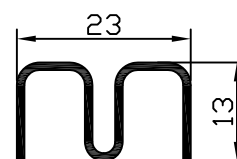

PS 2022

SÉRIE DE PERFIS - PS
Perfis à escala

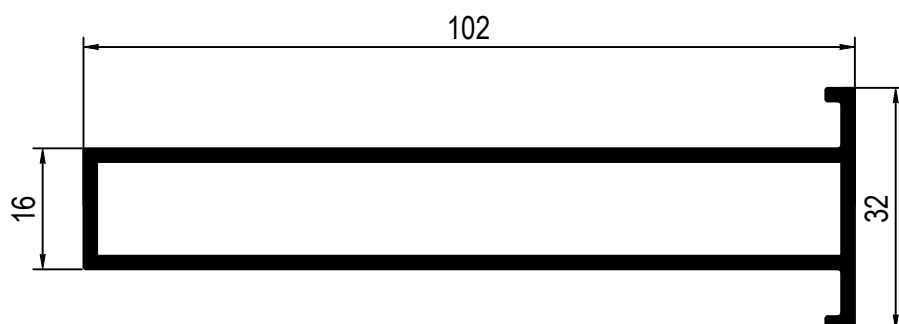

PS 2020

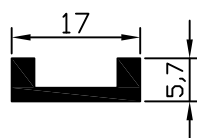

PS 2023

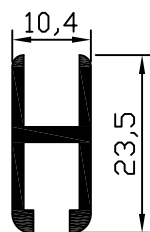

PS 2024



PS 2027

SÉRIE DE PERFIS - PS
Perfis à escala

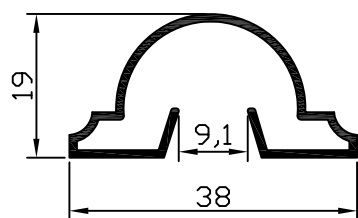

PS 2030

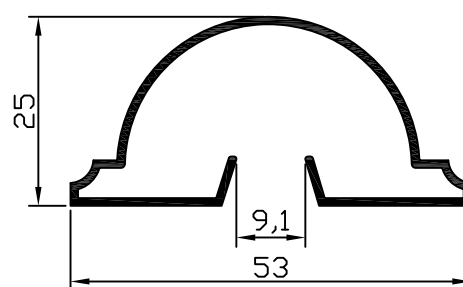

PS 2031

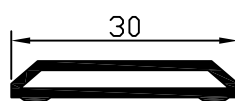

PS 2037

SÉRIE DE PERFIS - PS
Perfis à escala

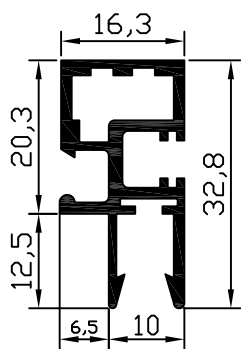

PS 2038

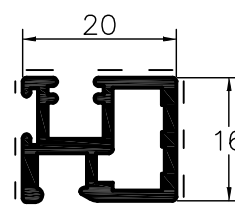

PS 2039

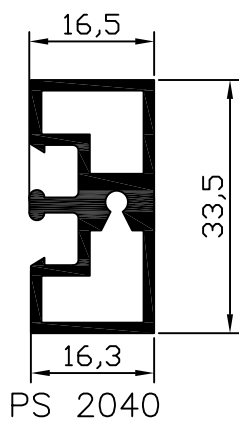

PS 2040

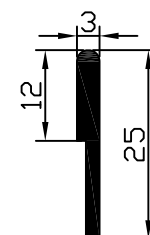

PS 2041

SÉRIE DE PERFIS - PS
Perfis à escala

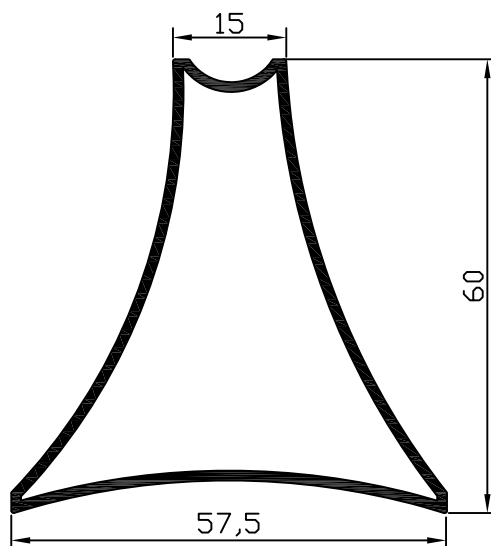

PS 2042

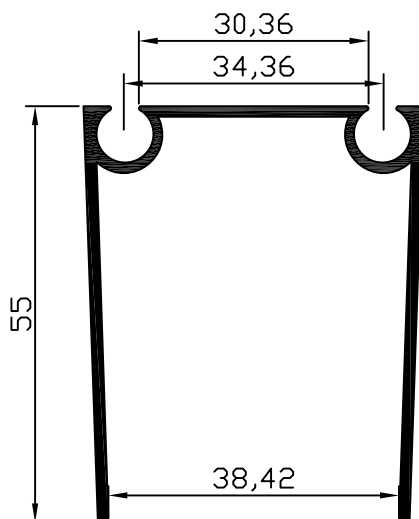

PS 2060

SÉRIE DE PERFIS - PS
Perfis à escala

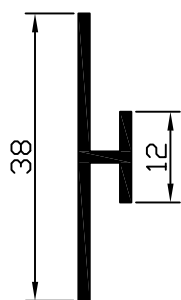

PS 2044

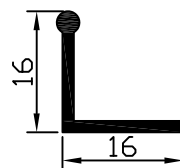

PS 2046

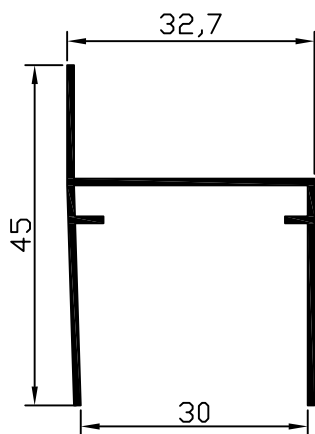

PS 2067

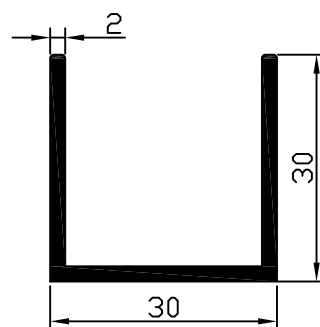

PS 2070

BARRAS RECTANGULARES

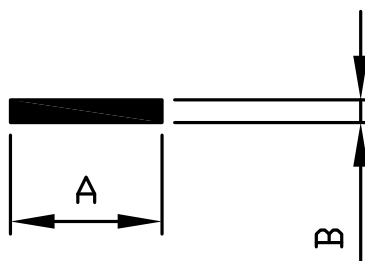

A	B	Kg/m	m²/m	Perfil
20	3	0,163	0,046	PS2100
20	4	0,217	0,048	PS2101
20	5	0,271	0,050	PS2102
25	8	0,548	0,066	PS2108
30	3	0,244	0,066	PS2110
30	5	0,405	0,070	PS2111
30	15	1,215	0,090	PS2111
40	3	0,324	0,086	PS2115
40	6	0,650	0,092	PS2118
40	8	0,867	0,096	PS2120
40	20	2,160	0,120	PS2125
50	10	1,357	0,120	PS2135
60	5	0,813	0,130	PS2137
80	5	1,080	0,170	PS2138
80	10	2,160	0,180	TS2114
95	5	1,258	0,200	PS2139
100	10	2,710	0,220	PS2140
150	10	6,075	0,320	PS2159
150	15	6,050	0,330	PS2160

CANTONEIRAS DE ABAS IGUAIS

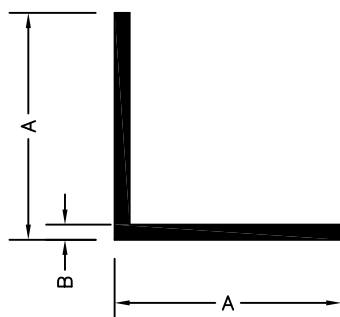

A	B	Kg/m	m ² /m	Perfil
15	1,5	0,120	0,033	PS2200
20	1,5	0,160	0,043	PS2201
25	1,5	0,198	0,053	PS2205
25	3	0,381	0,053	PS2207
30	1,5	0,239	0,063	PS2210
30	3	0,461	0,063	PS2214
40	2	0,423	0,084	PS2215
40	3	0,626	0,086	PS2220
50	3	0,789	0,106	PS2230
50	5	1,252	0,110	PS2235
60	6	1,854	0,132	PS2240

CANTONEIRAS ABAS DESIGUAIS

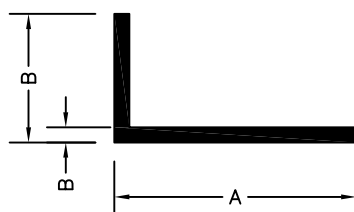

A	B	C	D	Kg/m	m ² /m	Perfil
30	15	2	2	0,233	0,09	PS2300
40	20	2	2	0,315	0,12	PS2320
50	20	1,8	1,8	0,331	0,14	PS2330
60	20	2	2	0,421	0,16	PS2343

PERFIS EM "T"

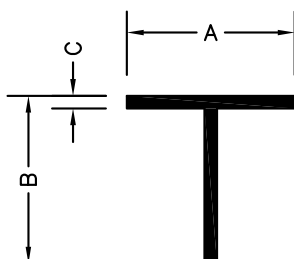

A	B	C	Kg/m	m2/m	Perfil
25	25	2	0,259	0,1	PS2400
25	25	3	0,381	0,1	PS2401
30	30	2	0,313	0,12	PS2410
30	30	3	0,46	0,12	PS2411

PERFIS REDONDOS - MACIÇOS



A	Kg/m	Perfil
6	0.077	PS 3000
8	0.136	PS 3005
10	0.213	PS 3010
16	0.545	PS 3015
30	1.909	PS 3030

TUBOS REDONDOS

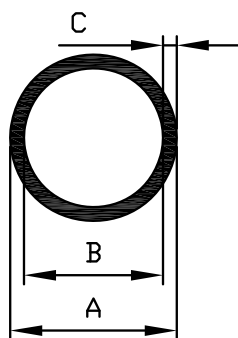

A	B	C	Kg/m	m2/m	Perfil
12	9	1,5	0,134	0,038	PS3102
16	13	1,5	0,190	0,050	PS3105
19,2	16,2	1,5	0,226	0,060	PS3108
22	19	1,5	0,261	0,069	PS3112
22	17	2,5	0,414	0,069	PS3114
25	23	2	0,413	0,079	PS3115
30	26	2	0,476	0,094	PS3116
35	31	2	0,560	0,110	PS3117
40	36	2	0,647	0,126	PS3118
45	41,6	1,7	0,594	0,141	PS3119
50	46	2	0,819	0,157	PS3120
60	56	2	0,990	0,188	PS3135
80	77	1,5	1,190	0,251	PS3125
100	96	2	1,663	0,314	PS3150

TUBOS QUADRADOS

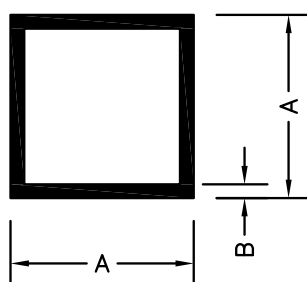

A	B	Kg/m	m²/m	Perfil
19	1,5	0,285	0,076	PS3205
20	2	0,390	0,080	PS3206
25	1,5	0,456	0,100	PS3208
30	1,5	0,463	0,120	PS3210
30	2	0,607	0,120	PS3211
35	2	0,716	0,140	PS3212
40	3	1,179	0,160	PS3213
40	1,6	0,666	0,160	PS3215
50	1,5	0,790	0,200	PS3218
50	2	1,040	0,200	PS3220
50	3	1,523	0,200	PS3221
60	1,5	0,951	0,240	PS3222
60	2	1,257	0,240	PS3223
65	1,5	1,033	0,260	PS3225
75	1,5	1,195	0,300	PS3230
80	1,5	1,190	0,320	PS3233
80	2	1,684	0,320	PS3235
85	2	1,800	0,340	PS3240
100	2	2,125	0,400	PS3245
150	2,5	4,103	0,600	PS3265

TUBOS RECTANGULARES

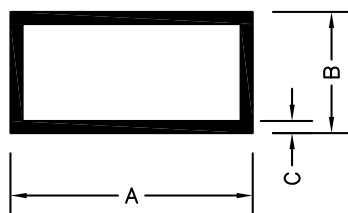

A	B	C	Kg/m	m2/m	Perfil
20	10	1,5	0,219	0,060	PS3300
30	15	1,5	0,342	0,090	PS3305
30	20	1,5	0,381	0,100	PS3306
40	20	1,5	0,437	0,120	PS3310
40	20	2	0,607	0,120	PS3311
50	15	1,2	0,406	0,130	PS3312
50	20	2	0,704	0,140	PS3314
50	25	1,5	0,583	0,150	PS3313
50	30	2	0,824	0,160	PS3315
60	15	1,6	0,624	0,150	PS3395
60	20	1,5	0,626	0,160	PS3316
60	30	2	0,909	0,180	PS3400
60	40	2	1,076	0,200	PS3317
65	30	2	0,987	0,190	PS3318
70	20	1,5	0,707	0,180	PS3319
70	35	2	1,091	0,210	PS3321
75	40	1,5	0,911	0,230	PS3325
80	20	1,5	0,786	0,200	PS3326
80	40	1,5	0,951	0,240	PS3327
80	40	2	1,273	0,240	PS3328
80	50	3	2,001	0,260	COR2280
100	20	1,5	0,948	0,240	PS3450
100	40	1,5	1,528	0,280	PS3329
100	45	1,5	1,29	0,290	PS3334
100	45	2,5	1,897	0,290	PS3330
100	50	2	1,577	0,300	PS3331
120	40	2,5	2,113	0,320	PS3332
140	70	2,5	2,778	0,420	PS3333
150	25	2,4	2,215	0,350	PS3335
150	50	2	2,117	0,400	PS3337
200	50	3	3,957	0,500	PS3500

aluminiosiberica.pai.pt



ALUMÍNIOS IBÉRICA, S.A.

**Sede e Fábrica: Rua do Parque Industrial, nº 126
4720-5 Lago Amares**

Telefs. 253 310 250 — 253 310 251 Fax: 253 311 830

Email: aluminiosiberica@mail.telepac.pt

Filiais:

**Rua da Mina, 562 - 4405-234 Canelas - V.N.Gaia
Telefs: 227 929 539 Fax: 227 629 514
Zona Industrial de Constantim, Lote 53
5000-082 Constantim - Vila Real
Telefs: 259 331 778 Fax: 259 338 552**



ALUMÍNIOS DE VISEU, L.D.A.

**Armazém: Est. do Campo de Aviação - CAMPO
3510-824 VISEU
Telefs. 232 459 138—232 459 741
Fax: 232 450 140
E-mail: geral@alviz.pt**



PALA - MIGUEL & REIS, LDA.

lhavo

**Sede: Zona industrial da Moita, Rua 7 lote 21—A
Gafanha da Encarnação — Apartado 523**

3834-909 lhavo

Telefs: 234 329 120 — Fax: 234 329 121

E-mail: pala.aluminio@sapo.pt

Leiria

Armazéns: Canhestro—Pousas 2410-235 LEIRIA

Telefs: 244 801 593 Fax: 244 855 702

E-mail: pala.leiria@sapo.pt

Algarve

Zona Industrial de Vilamoura

Lote 28—Apartado 841, 8126-910 Quarteira

Telefs: 289 322 748— Fax: 289 301 928

E-mail: pala.loule@sapo.pt



ANGULAR - Aluminios, Lda

Armazém: Av. Almirante Gago Coutinho

Portela de Sintra—Apartado 212

2711-901 SINTRA

Telefs. 219 244 074—219 244 101

Fax: 219 241 015